

1992 Vulcan 88 PARTS DIAGRAM

Footrests

F 2160

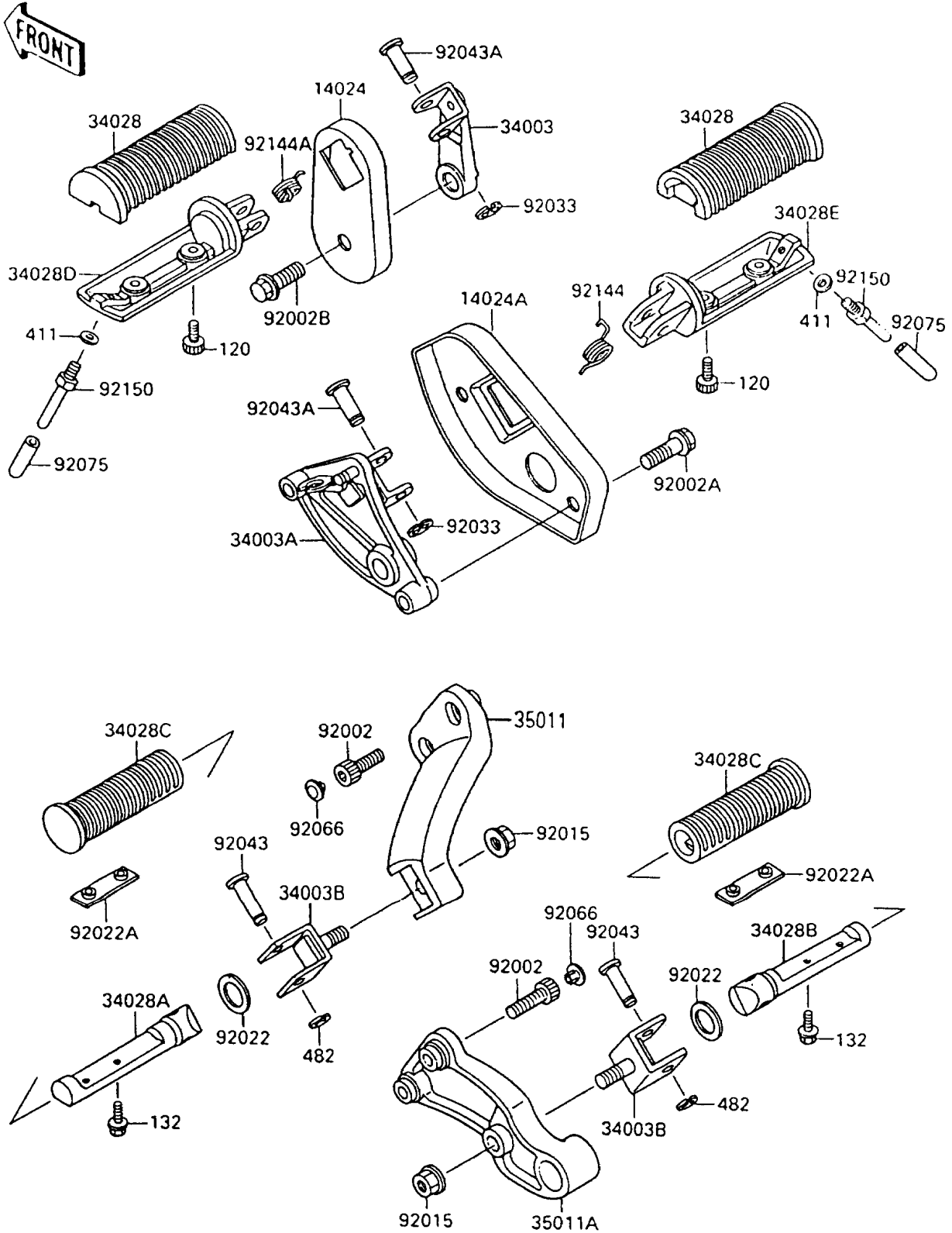

1992 Vulcan 88 PARTS LIST

Footrests

ITEM NAME	PART NUMBER	QUANTITY
BOLT-SOCKET (Ref # 120)	120S0512	4
BOLT-FLANGED-SMALL (Ref # 132)	132J0510	4
WASHER-PLAIN,6MM,BLACK (Ref # 411)	411F0600	2
CIRCLIP-TYPE-E (Ref # 482)	482L7000	2
COVER,FRONT STEP,LH (Ref # 14024)	14024-1435	1
COVER,FRONT STEP,RH (Ref # 14024A)	14024-1436	1
HOLDER-STEP,FR,LH (Ref # 34003)	34003-1290	1
HOLDER-STEP,FR,RH (Ref # 34003A)	34003-1291	1
HOLDER-STEP,RR (Ref # 34003B)	34003-1292	2
STEP,FR,RUBBER (Ref # 34028)	34028-1217	2
STEP,RR,LH (Ref # 34028A)	34028-1219	1
STEP,RR,RH (Ref # 34028B)	34028-1220	1
STEP,RR,RUBBER (Ref # 34028C)	34028-1221	2
STEP,FR,LH (Ref # 34028D)	34028-1245	1
STEP,FR,RH (Ref # 34028E)	34028-1246	1
STAY,REAR STEP,LH (Ref # 35011)	35011-1346	1
STAY,REAR STEP,RH (Ref # 35011A)	35011-1347	1
BOLT,SOCKET,8X25 (Ref # 92002)	92002-1442	4
BOLT,FLANGED,10X35 (Ref # 92002A)	92002-1829	2
BOLT,FLANGED,12X30 (Ref # 92002B)	92002-1925	1
NUT,FLANGED,10MM (Ref # 92015)	92015-1428	2
WASHER,20X30X2.3 (Ref # 92022)	92022-1568	2
WASHER,STEP (Ref # 92022A)	92022-1874	2
RING-SNAP,10MM (Ref # 92033)	92033-1166	2
PIN,8X36.5 (Ref # 92043)	92043-1339	2
PIN,12X37 (Ref # 92043A)	92043-1358	2
PLUG (Ref # 92066)	92066-1277	4
DAMPER (Ref # 92075)	92075-1980	2
SPRING,STEP RETURN (Ref # 92144)	92144-1126	1

1992 Vulcan 88 PARTS LIST

Footrests

ITEM NAME	PART NUMBER	QUANTITY
SPRING,STEP RETURN (Ref # 92144A)	92144-1210	1
BOLT,BANK SENSOR (Ref # 92150)	92150-1047	2