

1992 Vulcan 88 PARTS DIAGRAM

Front Fork

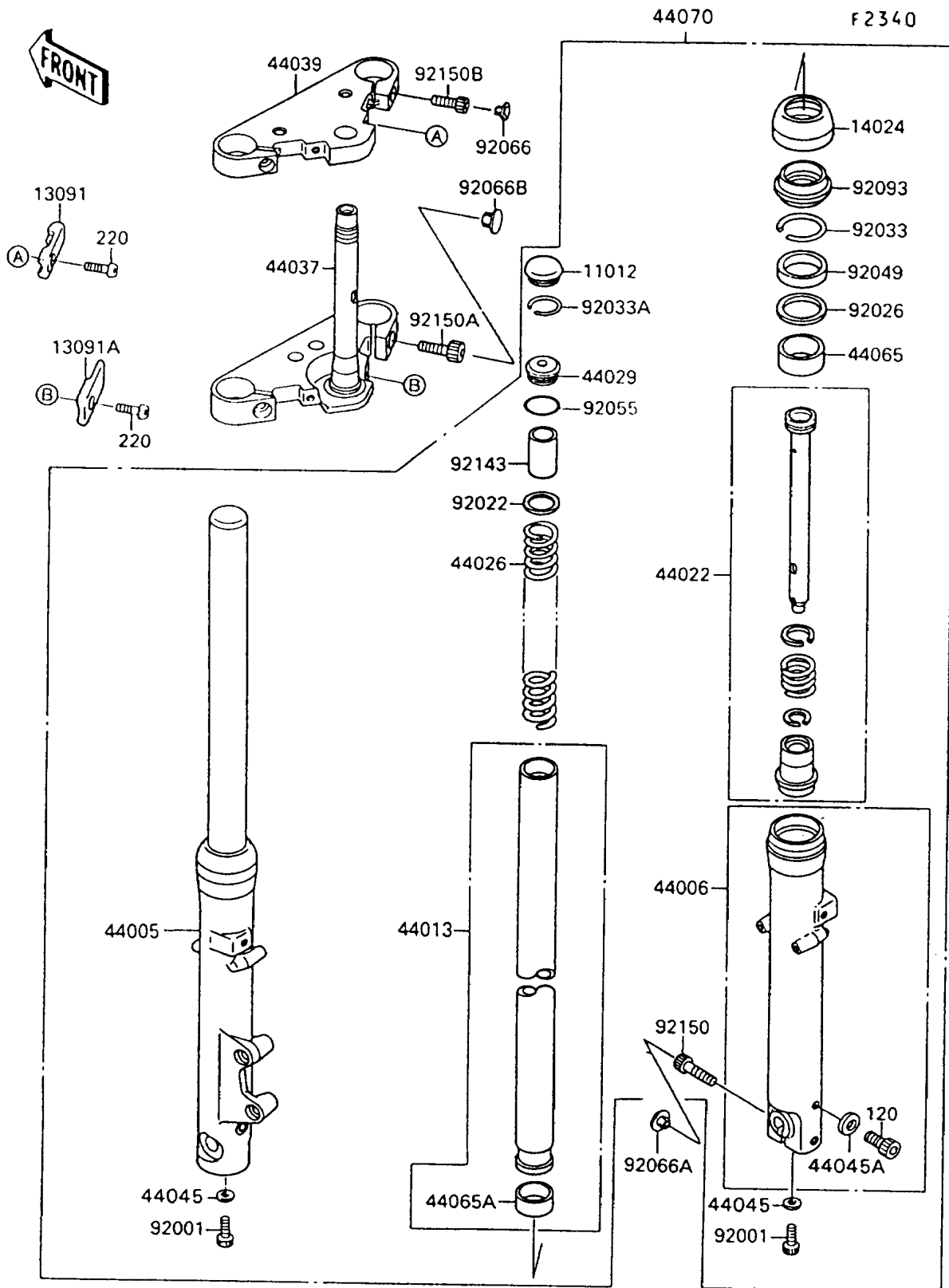

1992 Vulcan 88 PARTS LIST

Front Fork

| ITEM NAME | PART NUMBER | QUANTITY |
|--|-------------|----------|
| BOLT-SOCKET (Ref # 120) | 120P0608 | 2 |
| SCREW-PAN-CROS,6X20 (Ref # 220) | 220E0620 | 4 |
| CAP,FORK TOP (Ref # 11012) | 11012-1618 | 2 |
| HOLDER,UPP (Ref # 13091) | 13091-1482 | 2 |
| HOLDER,LWR (Ref # 13091A) | 13091-1483 | 2 |
| COVER,FORK OUTER TUBE (Ref # 14024) | 14024-1600 | 2 |
| PIPE-LEFT FORK OUTER (Ref # 44005) | 44005-1264 | 1 |
| PIPE-RIGHT FORK OUTER (Ref # 44006) | 44006-1261 | 1 |
| PIPE-FORK INNER (Ref # 44013) | 44013-1268 | 2 |
| CYLINDER-FORK (Ref # 44022) | 44022-1215 | 2 |
| SPRING-FRONT FORK (Ref # 44026) | 44026-1372 | 2 |
| SEAT-FORK SPRING (Ref # 44029) | 44029-1125 | 2 |
| HOLDER-FORK UNDER (Ref # 44037) | 44037-1235 | 1 |
| HOLDER-FORK UPPER (Ref # 44039) | 44039-1151 | 1 |
| GASKET,FORK CYLINDER BOLT (Ref # 44045) | 44045-051 | 2 |
| GASKET,DRAIN PLUG (Ref # 44045A) | 44045-052 | 2 |
| BUSHING-FRONT FORK (Ref # 44065) | 44065-1079 | 2 |
| BUSHING-FRONT FORK,INNER PIPE (Ref # 44065A) | 44065-1080 | 2 |
| DAMPER-ASSY,FORK (Ref # 44070) | 44070-5038 | 1 |
| BOLT,FORK CYLINDER (Ref # 92001) | 92001-1464 | 2 |
| WASHER (Ref # 92022) | 92022-1909 | 2 |
| SPACER,FORK OUTER (Ref # 92026) | 92026-1276 | 2 |
| RING-SNAP,FORK OUTER (Ref # 92033) | 92033-1222 | 2 |
| RING-SNAP,SPRING SEAT (Ref # 92033A) | 92033-1223 | 2 |
| SEAL-OIL,FORK (Ref # 92049) | 92049-1363 | 2 |
| RING-O,SPRING SEAT (Ref # 92055) | 92055-1363 | 2 |
| PLUG (Ref # 92066) | 92066-1277 | 2 |
| PLUG (Ref # 92066A) | 92066-1285 | 1 |
| PLUG (Ref # 92066B) | 92066-1302 | 2 |

1992 Vulcan 88 PARTS LIST

Front Fork

| ITEM NAME | PART NUMBER | QUANTITY |
|----------------------------------|-------------|----------|
| SEAL,FORK (Ref # 92093) | 92093-1268 | 2 |
| COLLAR,FORK SPRING (Ref # 92143) | 92143-1053 | 2 |
| BOLT,SOCKET,10X40 (Ref # 92150) | 92150-1029 | 1 |
| BOLT,SOCKET,12MM (Ref # 92150A) | 92150-1030 | 2 |
| BOLT,SOCKET,8MM (Ref # 92150B) | 92150-1031 | 2 |