

2019 KLX®150L PARTS DIAGRAM

Muffler(s)

E1140

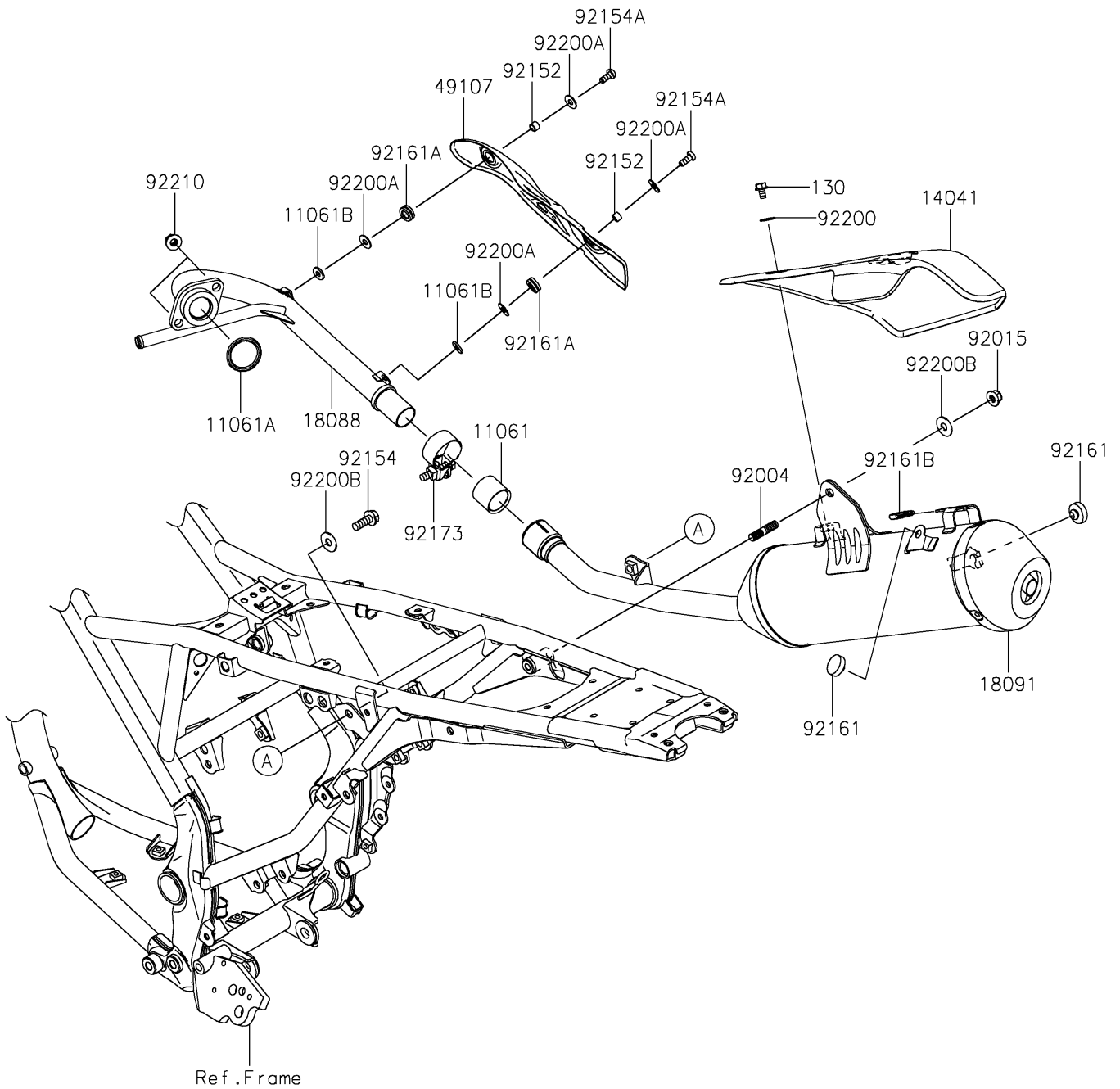

2019 KLX®150L PARTS LIST

Muffler(s)

ITEM NAME	PART NUMBER	QUANTITY
GASKET,MUFFLER JOINT (Ref # 11061)	11061-0866	1
GASKET,EXHAUST PIPE (Ref # 11061A)	11061-0871	1
GASKET,5.8X12X1.5 (Ref # 11061B)	11061-1148	2
COVER-COMP (Ref # 14041)	14041-0585	1
PIPE-EXHAUST (Ref # 18088)	18088-1329	1
BODY-COMP-MUFFLER (Ref # 18091)	18091-0950	1
COVER-EXHAUST PIPE (Ref # 49107)	49107-0780	1
STUD,8X22 (Ref # 92004)	92004-0040	1
NUT,8MM (Ref # 92015)	92015-1432	1
COLLAR,6.5X8.5X6 (Ref # 92152)	92152-1962	2
BOLT,8X16 (Ref # 92154)	92154-1228	1
BOLT,SOCKET,6X14 (Ref # 92154A)	92154-2817	2
DAMPER,MUFFLER (Ref # 92161)	92161-1284	2
DAMPER (Ref # 92161A)	92161-2110	2
DAMPER (Ref # 92161B)	92161-2125	1
CLAMP (Ref # 92173)	92173-1223	1
WASHER,6.5X16X1.0 (Ref # 92200)	92200-0796	1
WASHER,6.5X16X1 (Ref # 92200A)	92200-1974	4
WASHER,8.5X22X1.5 (Ref # 92200B)	92200-1975	2
NUT,8MM (Ref # 92210)	92210-0773	2
BOLT-FLANGED,6X10 (Ref # 130)	130BA0610	1