

# 2022 MULE SX™ PARTS DIAGRAM

Crankshaft/Piston(s)

E1320

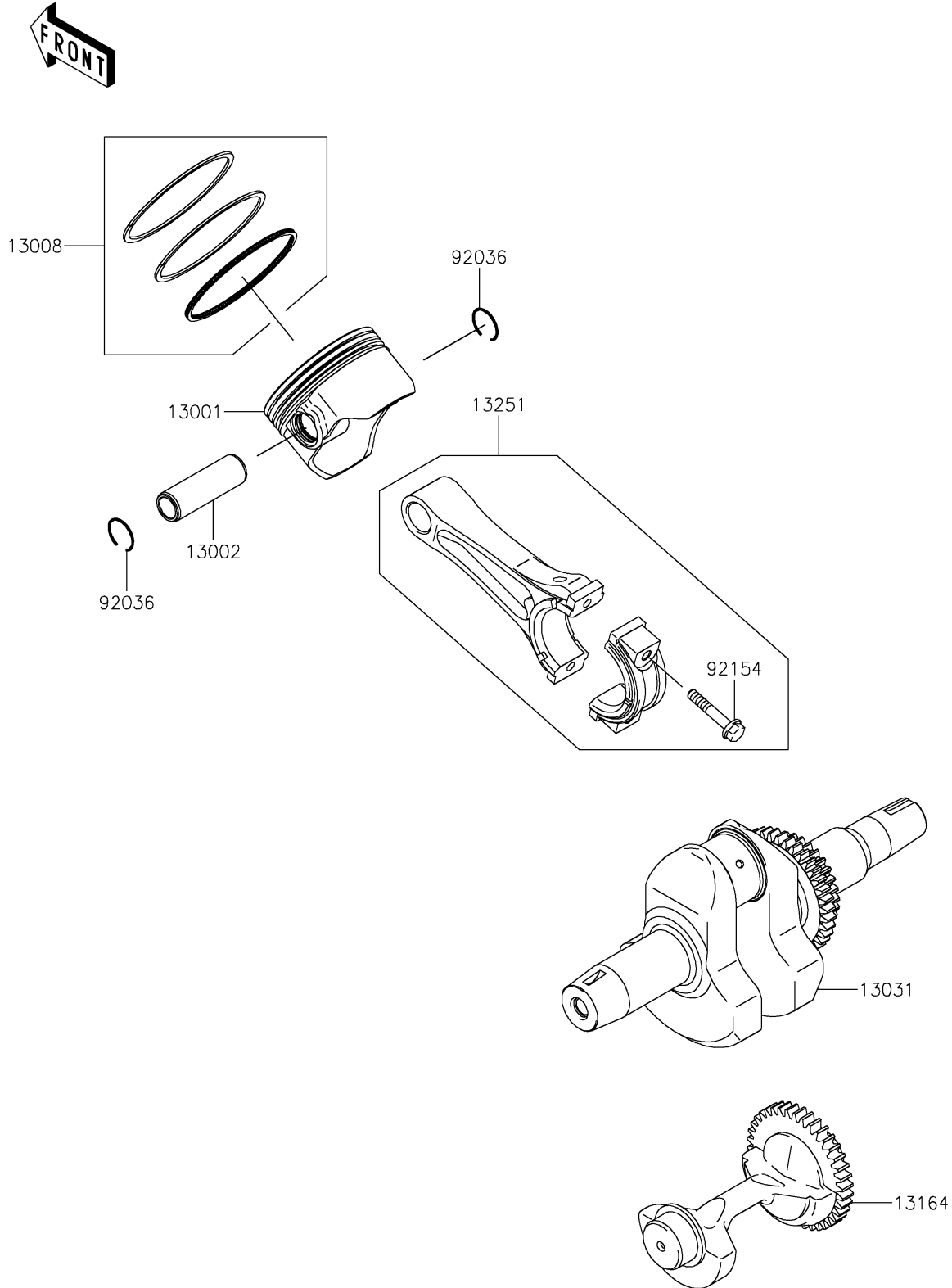

# 2022 MULE SX™ PARTS LIST

Crankshaft/Piston(s)

ITEM NAME	PART NUMBER	QUANTITY
-----------	-------------	----------