

# 2022 MULE SX™ PARTS DIAGRAM

## Guards/Cab Frame

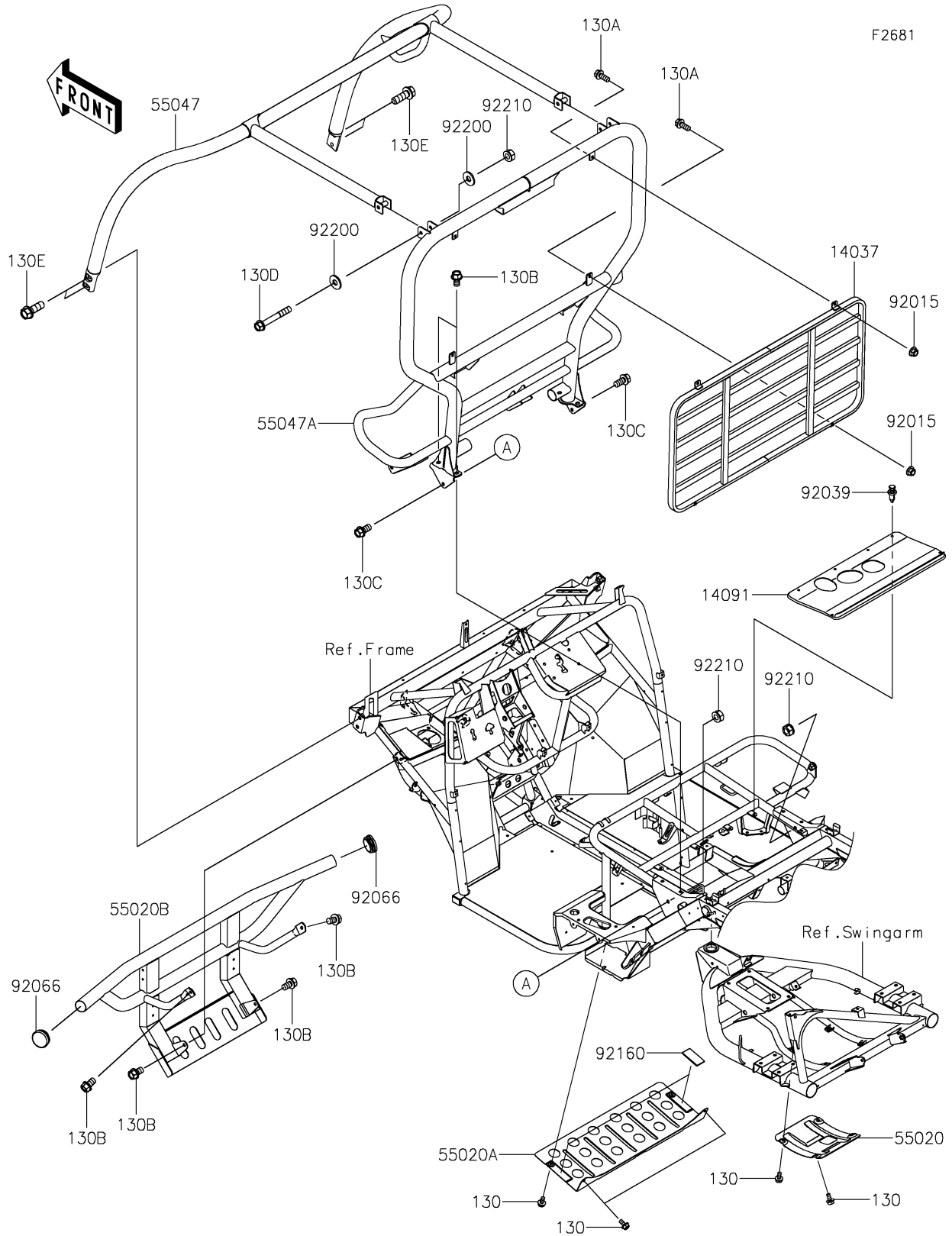

# 2022 MULE SX™ PARTS LIST

Guards/Cab Frame

ITEM NAME	PART NUMBER	QUANTITY
-----------	-------------	----------