

1997 Vulcan 1500 L PARTS DIAGRAM

Fuel Evaporative System

E1650

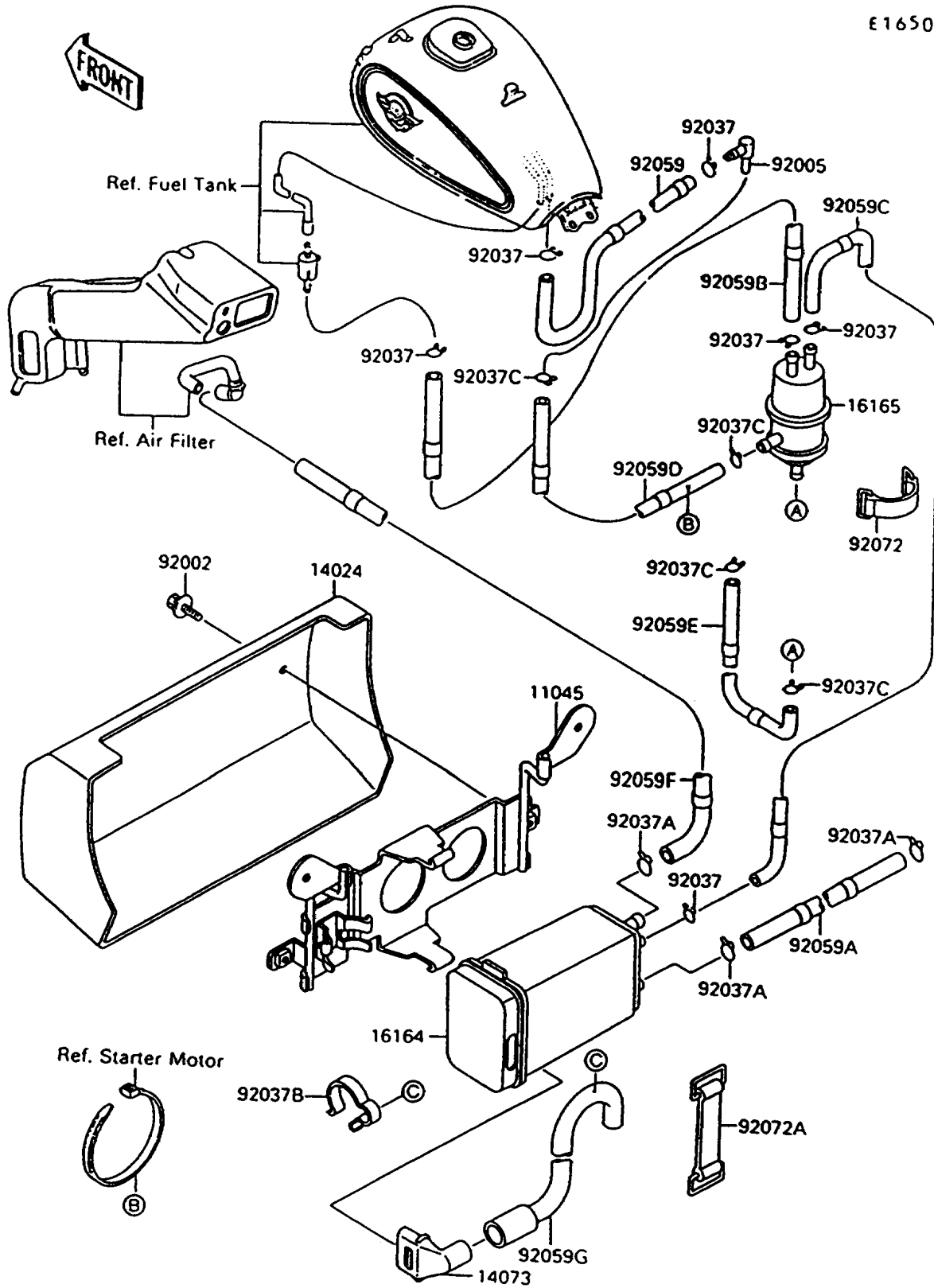

1997 Vulcan 1500 L PARTS LIST

Fuel Evaporative System

ITEM NAME	PART NUMBER	QUANTITY
BRACKET,CANISTER (Ref # 11045)	11045-1930	1
COVER,CANISTER (Ref # 14024)	14024-1546	1
DUCT,CANISTER (Ref # 14073)	14073-1219	1
CANISTER (Ref # 16164)	16164-1070	1
SEPARATOR (Ref # 16165)	16165-1001	1
BOLT,6X14 (Ref # 92002)	92002-1108	2
FITTING (Ref # 92005)	92005-1138	1
CLAMP,TUBE (Ref # 92037)	92037-010	6
CLAMP,HOSE (Ref # 92037A)	92037-1104	3
CLAMP,HOSE (Ref # 92037B)	92037-1689	1
CLAMP (Ref # 92037C)	92037-1712	4
TUBE,5X8X270,RED (Ref # 92059)	92059-1401	1
TUBE,7X12X940,YELLOW (Ref # 92059A)	92059-1414	1
TUBE,5X8X1100,BLUE (Ref # 92059B)	92059-1442	1
TUBE,CANISTER-SEPARATOR,BLUE (Ref # 92059C)	92059-1867	1
TUBE,5X10X1100,RED (Ref # 92059D)	92059-1870	1
TUBE,4X9X1087,WHITE (Ref # 92059E)	92059-1871	1
TUBE,7X12X945,GREEN (Ref # 92059F)	92059-1872	1
TUBE,CANISTER (Ref # 92059G)	92059-1876	1
BAND,L=50 (Ref # 92072)	92072-066	1
BAND,L=100 (Ref # 92072A)	92072-071	1