

1997 Vulcan 1500 L PARTS DIAGRAM

Front Brake

F2292

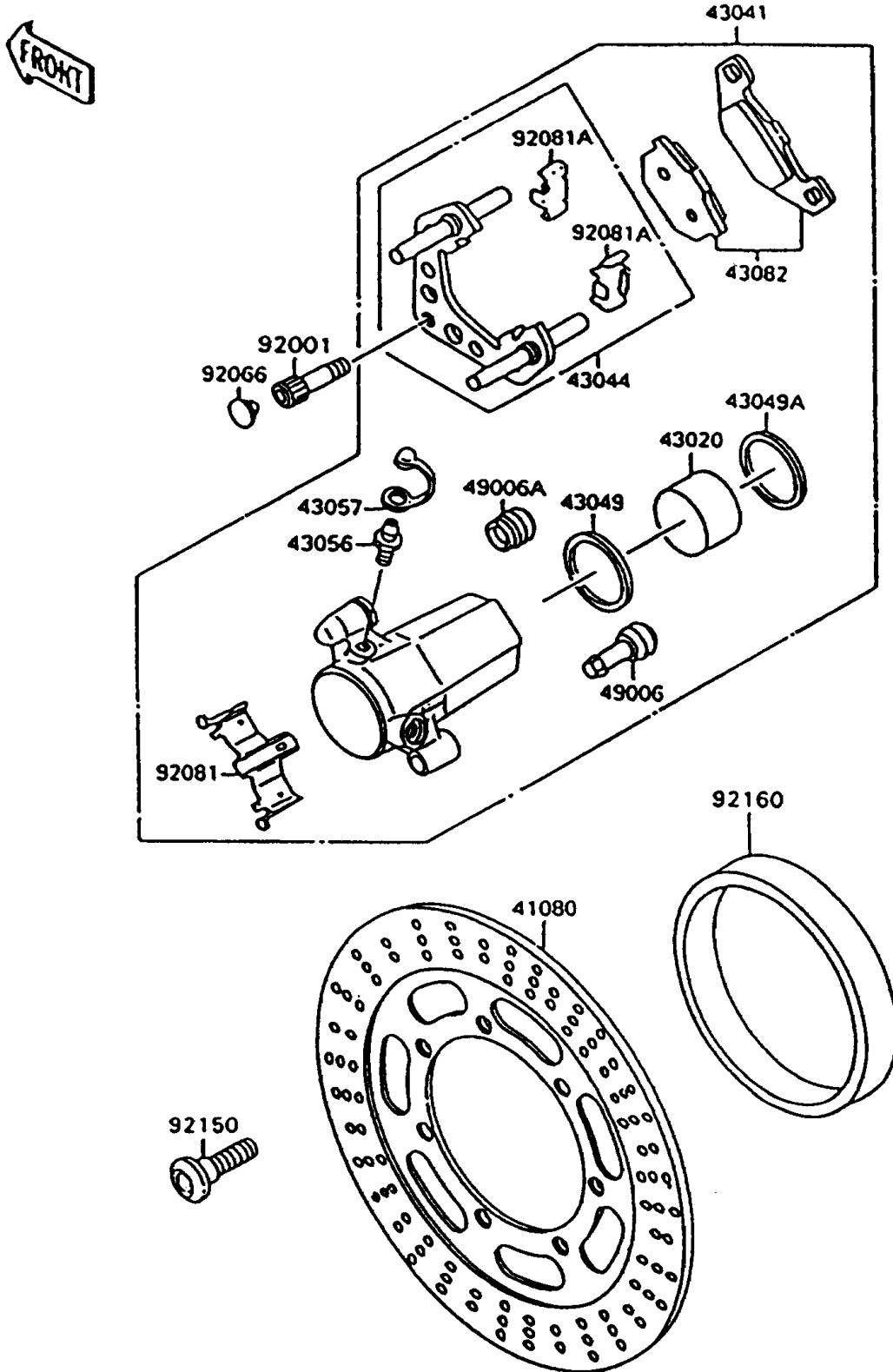

1997 Vulcan 1500 L PARTS LIST

Front Brake

ITEM NAME	PART NUMBER	QUANTITY
DISC,FR,SILVER NO.1 (Ref # 41080)	41080-1401-CM	1
PISTON-COMP-BRAKE (Ref # 43020)	43020-1066	1
CALIPER-ASSY,FR,LH,SILVER (Ref # 43041)	43041-1565-GN	1
HOLDER-COMP-CALIPER,FR,LH (Ref # 43044)	43044-1102	1
RING,PISTON SEAL (Ref # 43049)	43049-002	1
PACKING,PISTON (Ref # 43049A)	43049-1028	1
BREATHER-BRAKE (Ref # 43056)	43056-1054	1
CAP-BREATHER (Ref # 43057)	43057-003	1
PAD-ASSY-BRAKE (Ref # 43082)	43082-1167	1
BOOT,CALIPER (Ref # 49006)	49006-1094	1
BOOT,CALIPER (Ref # 49006A)	49006-1095	1
BOLT,SOCKET,10X33 (Ref # 92001)	92001-1901	2
PLUG (Ref # 92066)	92066-1285	2
SPRING,PAD (Ref # 92081)	92081-1525	1
SPRING,PAD STOPPER (Ref # 92081A)	92081-1661	2
BOLT,SOCKET,8X30 (Ref # 92150)	92150-1771	7
DAMPER,DISC PLATE (Ref # 92160)	92160-1504	1