

2009 KLR™ 650 PARTS DIAGRAM

Front Fork

F2340

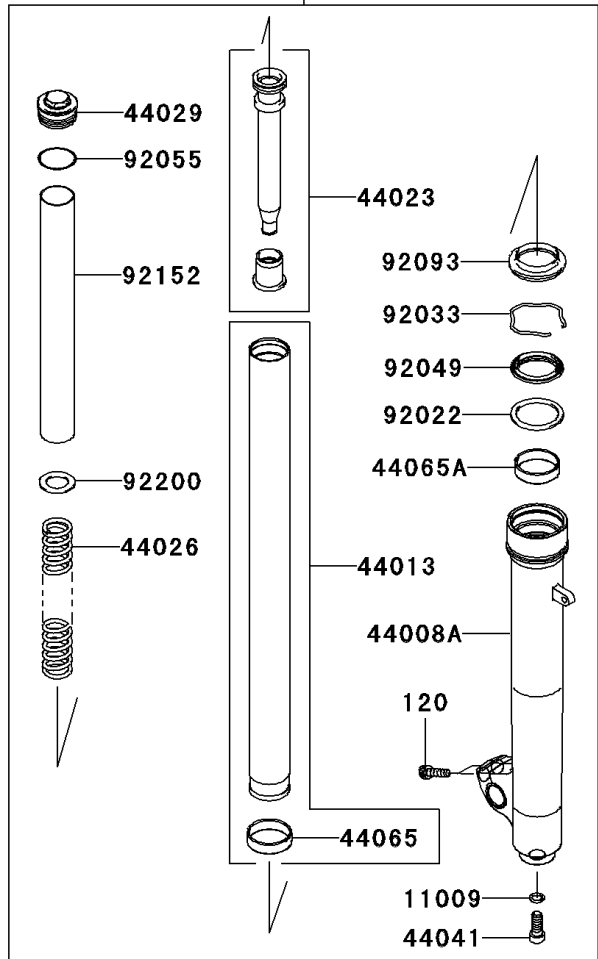
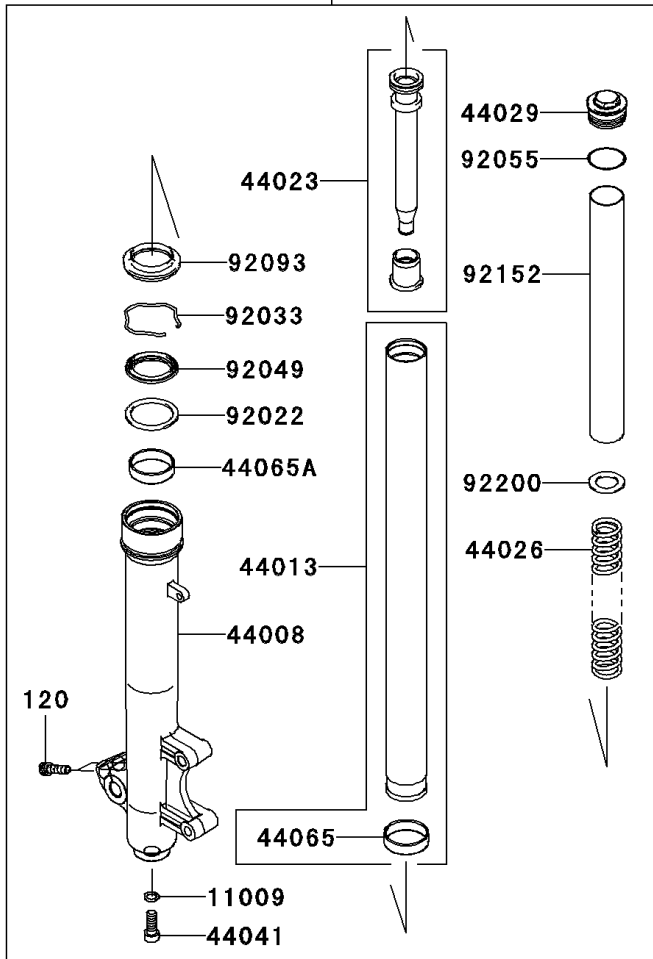
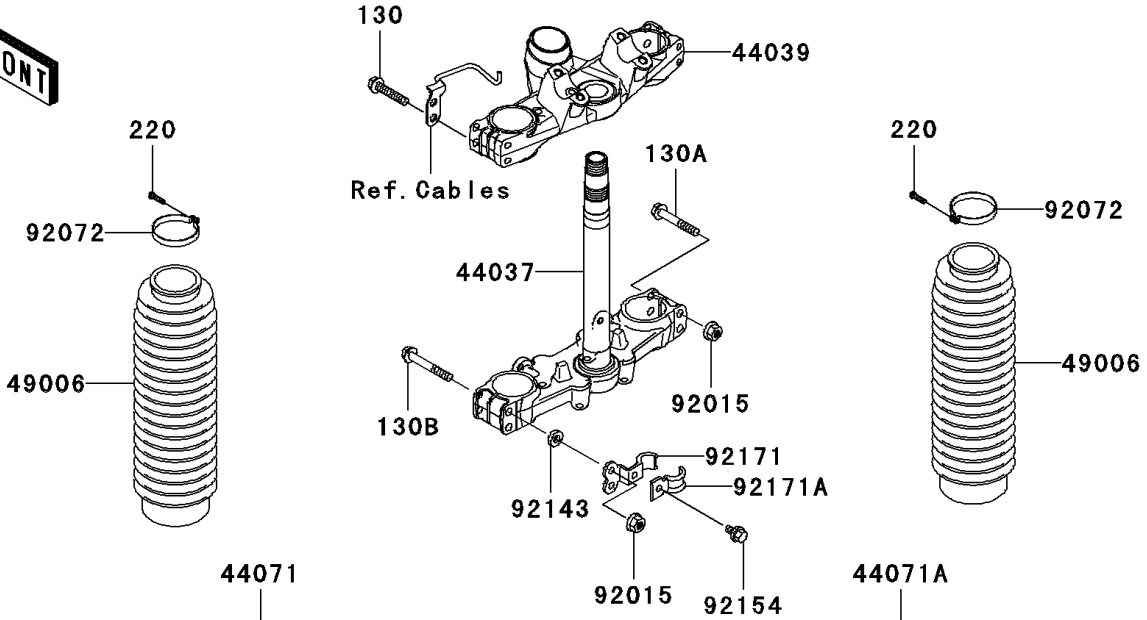

2009 KLR™ 650 PARTS LIST

Front Fork

ITEM NAME	PART NUMBER	QUANTITY
BOLT-SOCKET,8X30 (Ref # 120)	120CA0830	4
BOLT-FLANGED,8X40 (Ref # 130)	130BA0840	4
BOLT-FLANGED,8X50 (Ref # 130A)	130BA0850	2
BOLT-FLANGED,8X55 (Ref # 130B)	130BA0855	2
SCREW-PAN-CROS,4X16 (Ref # 220)	220C0416	2
GASKET,PIPE-COMP-SUSP (Ref # 11009)	11009-1325	2
PIPE-FORK OUTER,LH,P.SILVER (Ref # 44008)	44008-0021-458	1
PIPE-FORK OUTER,RH,P.SILVER (Ref # 44008A)	44008-0023-458	1
PIPE-FORK INNER (Ref # 44013)	44013-0107	2
CYLINDER-SET-FORK (Ref # 44023)	44023-0060	2
SPRING-FRONT FORK (Ref # 44026)	44026-0112	2
SEAT-FORK SPRING (Ref # 44029)	44029-0005	2
HOLDER-FORK UNDER,P.SILVER (Ref # 44037)	44037-0054-458	1
HOLDER-FORK UPPER,P.SILVER (Ref # 44039)	44039-0047-458	1
BOLT,SOCKET,FORK CYLINDER (Ref # 44041)	44041-040	2
BUSHING-FRONT FORK,INNER TUBE (Ref # 44065)	44065-0014	2
BUSHING-FRONT FORK,OUTER TUBE (Ref # 44065A)	44065-1115	2
DAMPER-ASSY,FORK,LH,P.SILVER (Ref # 44071)	44071-0343-458	1
DAMPER-ASSY,FORK,RH,P.SILVER (Ref # 44071A)	44071-0344-458	1
BOOT,FORK,BLACK (Ref # 49006)	49006-1266-BD	2
NUT,FLANGED,8MM (Ref # 92015)	92015-1406	4
WASHER,FORK OUTER TUBE (Ref # 92022)	92022-1298	2
RING-SNAP (Ref # 92033)	92033-1036	2
SEAL-OIL,FORK OUTER TUBE (Ref # 92049)	92049-1356	2
RING-O (Ref # 92055)	92055-1321	2
BAND,BOOT (Ref # 92072)	92072-1077	2
SEAL,DUST (Ref # 92093)	92093-0036	2
COLLAR (Ref # 92143)	92143-1770	2
COLLAR (Ref # 92152)	92152-0603	2

2009 KLR™ 650 PARTS LIST

Front Fork

ITEM NAME	PART NUMBER	QUANTITY
BOLT,FLANGED,6X10 (Ref # 92154)	92154-0111	1
CLAMP (Ref # 92171)	92171-1744	1
CLAMP (Ref # 92171A)	92171-1745	1
WASHER (Ref # 92200)	92200-1467	2