

1998 Vulcan 1500 Classic PARTS DIAGRAM

Taillight(s)

F2720

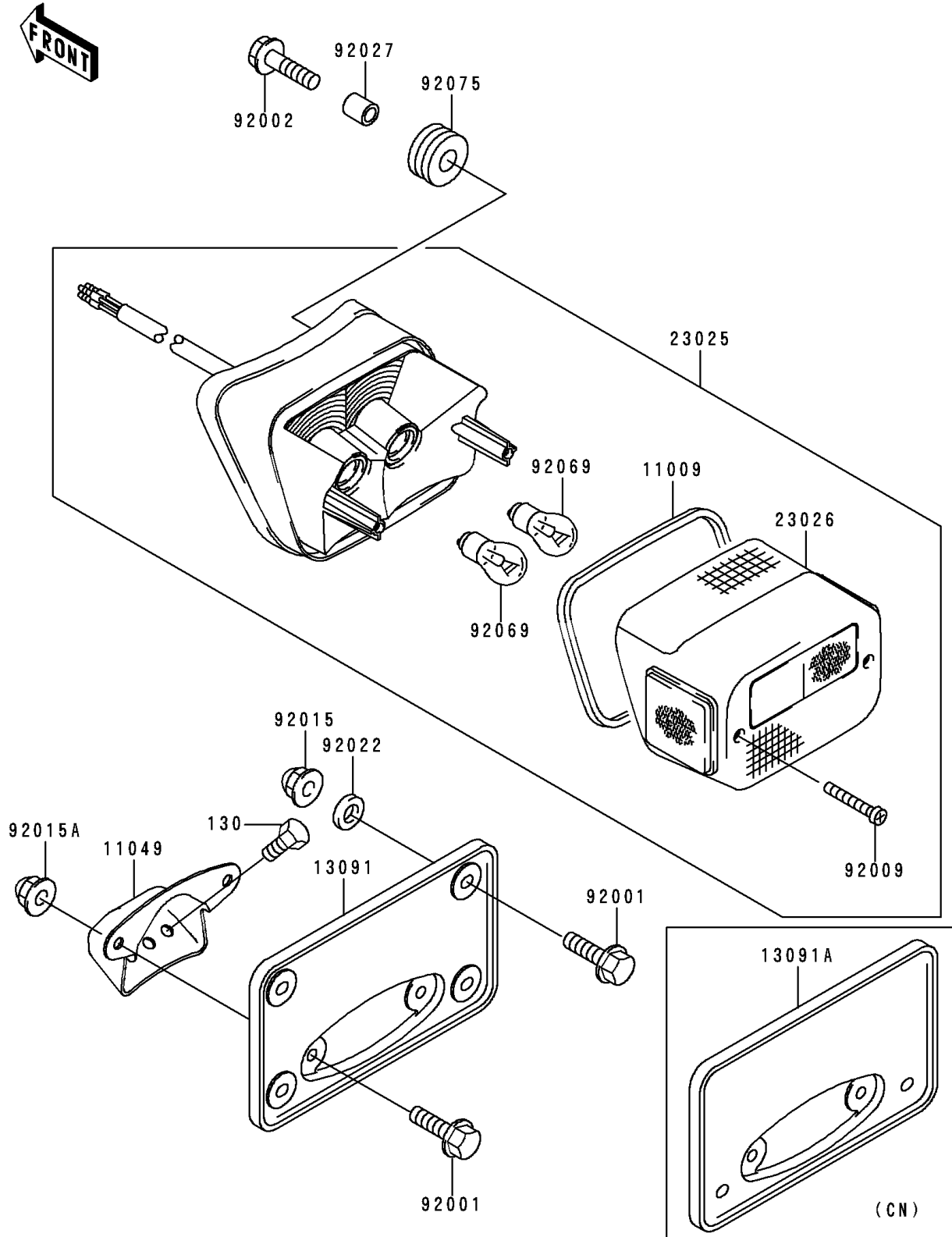

1998 Vulcan 1500 Classic PARTS LIST

Taillight(s)

ITEM NAME	PART NUMBER	QUANTITY
-----------	-------------	----------