

2002 Vulcan 1500 Classic PARTS DIAGRAM

Cylinder Head

E1111

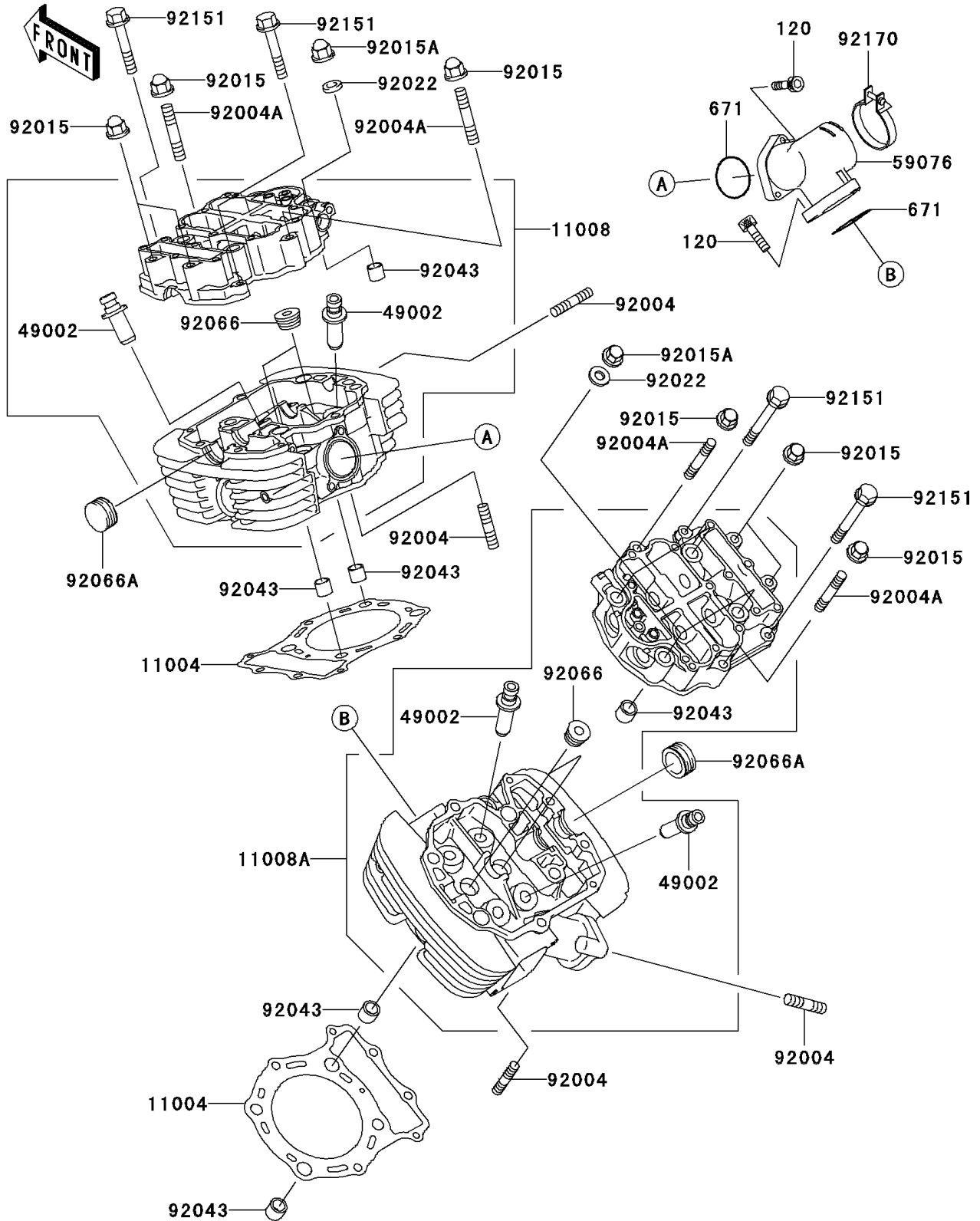

2002 Vulcan 1500 Classic PARTS LIST

Cylinder Head

ITEM NAME	PART NUMBER	QUANTITY
BOLT-SOCKET (Ref # 120)	120Z0620	4
O RING (Ref # 671)	671E2540	2
GASKET-HEAD (Ref # 11004)	11004-1334	2
HEAD-COMP-CYLINDER,FR (Ref # 11008)	11008-1338	1
HEAD-COMP-CYLINDER,RR (Ref # 11008A)	11008-1339	1
GUIDE-VALVE (Ref # 49002)	49002-1088	AR
MANIFOLD-INTAKE (Ref # 59076)	59076-1105	1
STUD,8X25 (Ref # 92004)	92004-1214	8
STUD,8X46.5 (Ref # 92004A)	92004-1224	4
NUT,FLANGED,8MM (Ref # 92015)	92015-1406	8
NUT,12MM (Ref # 92015A)	92015-1991	8
WASHER,12.3X25X3.2 (Ref # 92022)	92022-1862	8
PIN,13X16X14 (Ref # 92043)	92043-1608	8
PLUG,PT1/2X12.5 (Ref # 92066)	92066-1253	4
PLUG (Ref # 92066A)	92066-1442	2
BOLT,6X115 (Ref # 92151)	92151-1058	4
CLAMP (Ref # 92170)	92170-1644	1