

2002 Vulcan 1500 Classic PARTS DIAGRAM

Oil Pump/Oil Filter

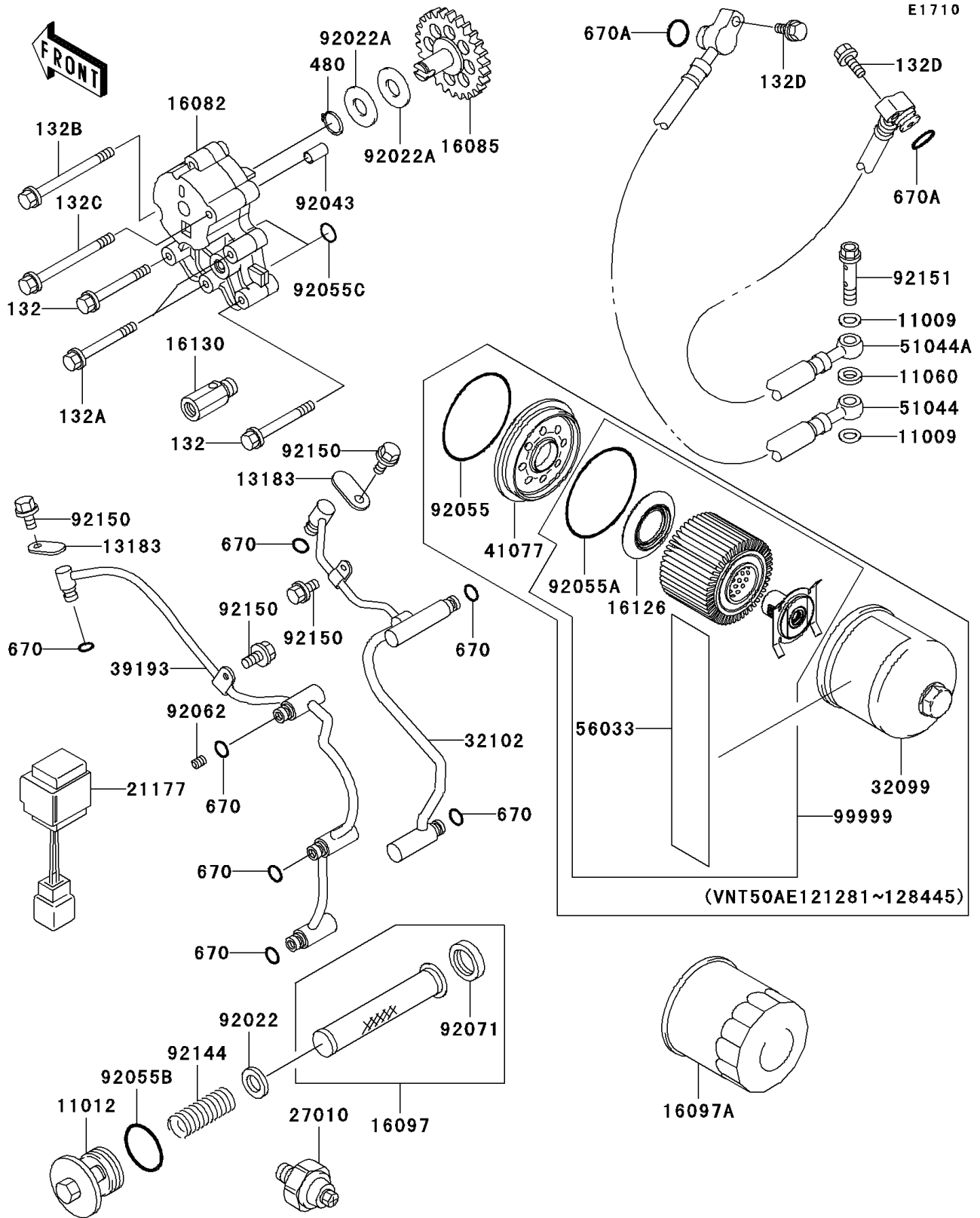

2002 Vulcan 1500 Classic PARTS LIST

Oil Pump/Oil Filter

ITEM NAME	PART NUMBER	QUANTITY
BOLT-FLANGED-SMALL (Ref # 132)	132G0645	2
BOLT-FLANGED-SMALL (Ref # 132A)	132G0655	2
BOLT-FLANGED-SMALL (Ref # 132B)	132G0660	1
BOLT-FLANGED-SMALL (Ref # 132C)	132G0670	1
GASKET,8.2X14X1.0 (Ref # 11009)	11009-1344	2
CAP,OIL FILTER (Ref # 11012)	11012-1461	1
GASKET,PIPE JOINT (Ref # 11060)	11060-1739	1
PLATE (Ref # 13183)	13183-1071	2
PUMP-ASSY-OIL (Ref # 16082)	16082-1155	1
GEAR,OIL PUMP,39T (Ref # 16085)	16085-1345	1
FILTER-ASSY-OIL (Ref # 16097)	16097-1058	1
FILTER-ASSY-OIL (Ref # 16097A)	16097-1072	1
VALVE-ASSY-RELIEF (Ref # 16130)	16130-1059	1
CONTROLLER,OIL LAMP (Ref # 21177)	21177-1058	1
SWITCH,OIL PRESSURE (Ref # 27010)	27010-1360	1
PIPE (Ref # 32102)	32102-1409	1
PIPE-OIL (Ref # 39193)	39193-1036	1
TUBE-ASSY,FR (Ref # 51044)	51044-1182	1
TUBE-ASSY,RR (Ref # 51044A)	51044-1183	1
WASHER,20.1X28X1 (Ref # 92022)	92022-1547	1
WASHER,12X27.5X1.0 (Ref # 92022A)	92022-1852	2
PIN,6.2X8X14 (Ref # 92043)	92043-1263	1
RING-O,35.2X2.4 (Ref # 92055B)	92055-1358	1
RING-O,13.2X2.4 (Ref # 92055C)	92055-1373	2
NOZZLE,6X8,GREEN (Ref # 92062)	92062-1078	1
GROMMET,OIL STRAINER (Ref # 92071)	92071-100	1
SPRING (Ref # 92144)	92144-1106	1
BOLT,6X12 (Ref # 92150)	92150-1868	4
BOLT,8X35 (Ref # 92151)	92151-1355	1

2002 Vulcan 1500 Classic PARTS LIST

Oil Pump/Oil Filter

ITEM NAME	PART NUMBER	QUANTITY
BOLT-FLANGED-SMALL (Ref # 132D)	132J0625	2
CIRCLIP-TYPE-C,12MM (Ref # 480)	480J1200	1
O RING,8MM (Ref # 670)	670D1508	7
O RING (Ref # 670A)	670D2010	2