

# 1999 Vulcan 1500 Classic PARTS DIAGRAM

Fuel Tank(VN1500-E2-E4)

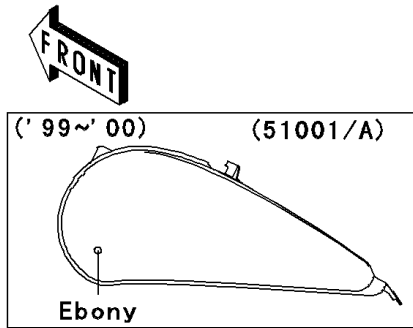

WOD

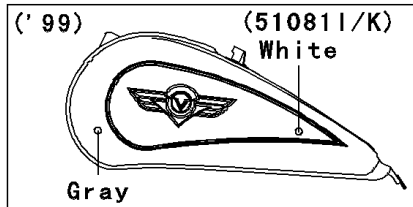

Gray

WD

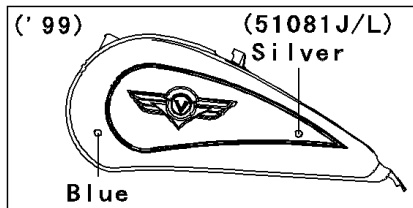

Blue

WD

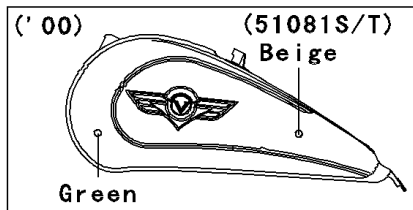

Green

WD

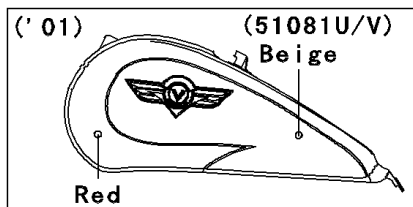

Red

WD

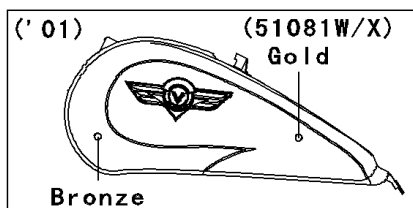

Bronze

WD

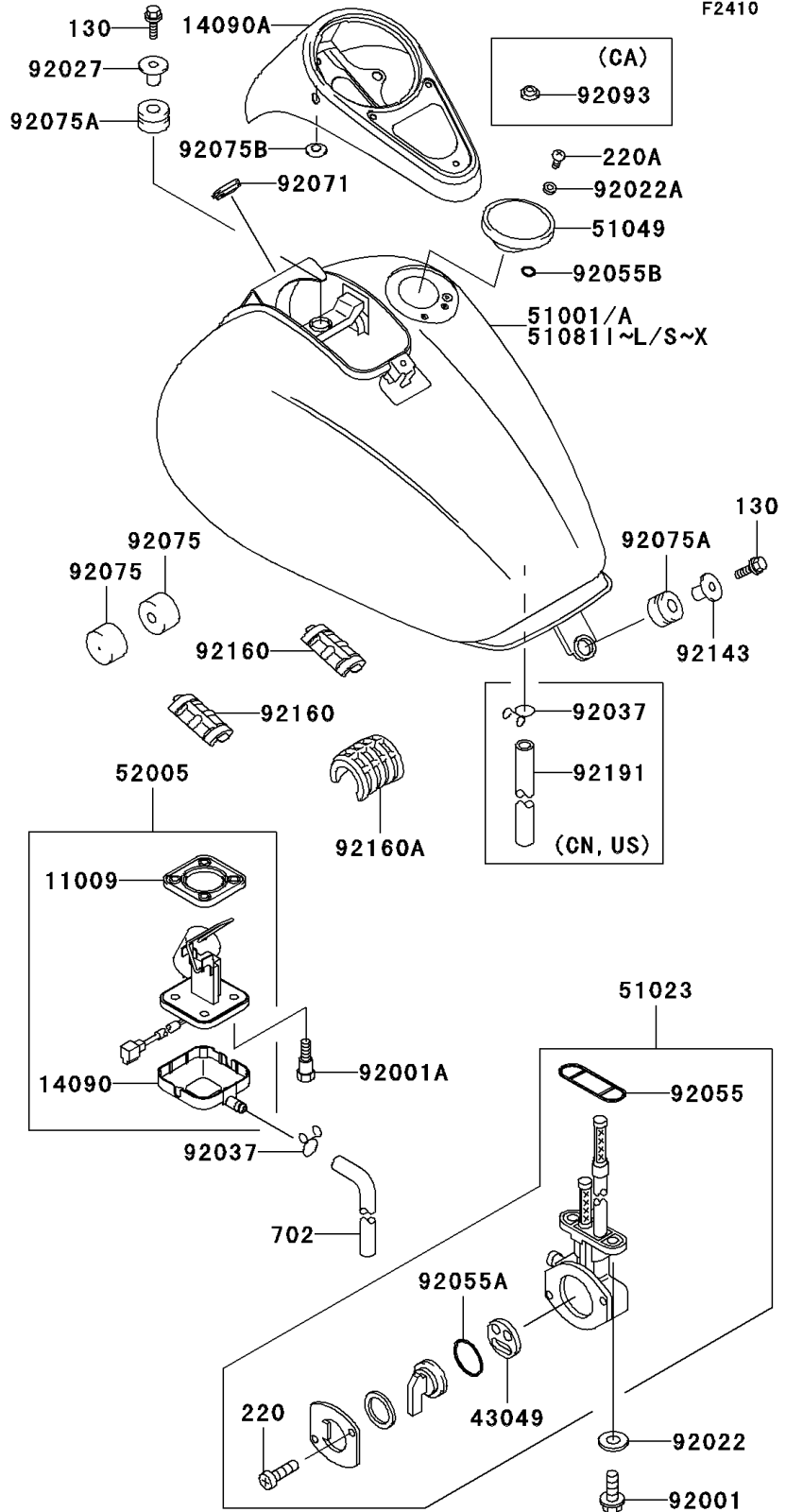

F2410

# 1999 Vulcan 1500 Classic PARTS LIST

Fuel Tank(VN1500-E2-E4)

ITEM NAME	PART NUMBER	QUANTITY
GASKET,FUEL GAUGE (Ref # 11009)	11009-1656	1
COVER,FUEL GAUGE (Ref # 14090)	14090-1624	1
COVER,METER (Ref # 14090A)	14090-1674	1
PACKING,TAP VALVE (Ref # 43049)	43049-1066	1
TAP-ASSY,FUEL (Ref # 51023)	51023-1226	1
CAP-TANK,FUEL (Ref # 51049)	51049-1103	1
BOLT-FLANGED,8X30 (Ref # 130)	130H0830	2
SCREW-PAN-CROS (Ref # 220)	220B0308	2
SCREW-PAN-CROS (Ref # 220A)	220D0510	2
TUBE-RUBBER,7X10X860 (Ref # 702)	702A07860	1
GAUGE,FUEL (Ref # 52005)	52005-1129	1
BOLT,6X25 (Ref # 92001)	92001-1524	2
BOLT,FUEL GAUGE (Ref # 92001A)	92001-1705	4
WASHER,6.2X11X1.5 (Ref # 92022)	92022-183	2
WASHER,5.1X10X1.0 (Ref # 92022A)	92022-1977	2
COLLAR,L=19.3 (Ref # 92027)	92027-1780	1
RING-O,FUEL TAP PACKING (Ref # 92055)	92055-1112	1
RING-O,TAP LEVER (Ref # 92055A)	92055-1419	1
RING-O (Ref # 92055B)	92055-1552	2
GROMMET (Ref # 92071)	92071-1187	1
DAMPER,FUEL TANK (Ref # 92075)	92075-125	2
DAMPER (Ref # 92075A)	92075-1736	2
DAMPER,RUBBER (Ref # 92075B)	92075-261	1
COLLAR (Ref # 92143)	92143-1835	1
DAMPER,FUEL TANK (Ref # 92160)	92160-1751	2
DAMPER,FUEL TANK (Ref # 92160A)	92160-1799	1
TANK-COMP-FUEL,EBONY (Ref # 51001)	51001-1549-H8	1
TANK-COMP-FUEL,EBONY (Ref # 51001A)	51001-1558-H8	1
TANK-COMP-FUEL,WHITE/GRAY (Ref # 51081I)	51081-5094-96	1

# 1999 Vulcan 1500 Classic PARTS LIST

Fuel Tank(VN1500-E2-E4)

ITEM NAME	PART NUMBER	QUANTITY
TANK-COMP-FUEL,BLUE/SILVER (Ref # 51081J)	51081-5095-H6	1
TANK-COMP-FUEL,WHITE/GRAY (Ref # 51081K)	51081-5096-96	1
TANK-COMP-FUEL,BLUE/SILVER (Ref # 51081L)	51081-5097-H6	1
CLAMP,TUBE (Ref # 92037)	92037-147	1
CLAMP,TUBE (Ref # 92037)	92037-147	2
SEAL,FUEL TANK CAP (Ref # 92093)	92093-1030	1
TUBE,DRAIN (Ref # 92191)	92191-1272	1