

2020 KLX® 250 CAMO PARTS DIAGRAM

Fuel Tank

F2410

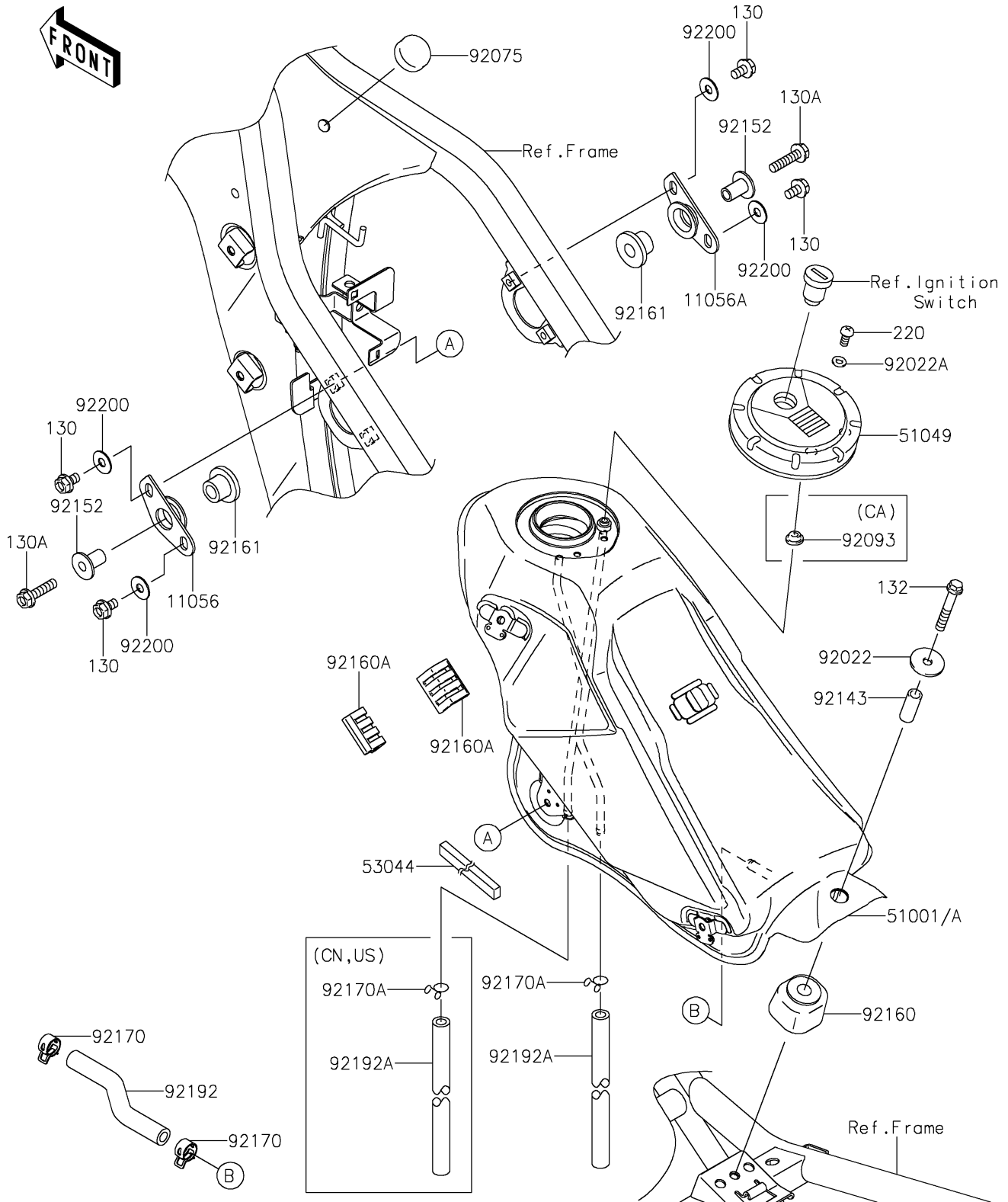

2020 KLX® 250 CAMO PARTS LIST

Fuel Tank

ITEM NAME	PART NUMBER	QUANTITY
BRACKET,ADJUSTER,LH (Ref # 11056)	11056-1452	1
BRACKET,ADJUSTER,RH (Ref # 11056A)	11056-1457	1
TANK-COMP-FUEL,F.S.BLACK (Ref # 51001)	51001-0294-25Q	1
TANK-COMP-FUEL,F.S.BLACK (Ref # 51001A)	51001-0297-25Q	1
CAP-TANK,FUEL (Ref # 51049)	51049-0049	1
TRIM,L=490 (Ref # 53044)	53044-1209	1
WASHER,6.5X24X2 (Ref # 92022)	92022-1690	1
WASHER,5.1X10X1.0 (Ref # 92022A)	92022-1977	2
DAMPER,9X24X14 (Ref # 92075)	92075-281	1
SEAL,FUEL TANK CAP (Ref # 92093)	92093-1030	1
COLLAR,6.8X10X24.5 (Ref # 92143)	92143-1459	1
COLLAR,6.5X10X18 (Ref # 92152)	92152-1560	2
DAMPER,FUEL TANK,RR (Ref # 92160)	92160-1254	1
DAMPER,FUEL TANK (Ref # 92160A)	92160-1328	2
DAMPER,10X16X15 (Ref # 92161)	92161-1397	2
CLAMP (Ref # 92170)	92170-1492	2
CLAMP,TUBE (Ref # 92170A)	92170-1834	1
TUBE (Ref # 92192)	92192-0604	1
TUBE,7X12X700 (Ref # 92192A)	92192-0778	1
WASHER,6.5X18X1.6 (Ref # 92200)	92200-0766	4
BOLT-FLANGED,6X10 (Ref # 130)	130BB0610	4
BOLT-FLANGED,6X25 (Ref # 130A)	130BB0625	2
BOLT-FLANGED-SMALL,6X35 (Ref # 132)	132BA0635	1
SCREW-PAN-CROS,5X10 (Ref # 220)	220AA0510	2
CLAMP,TUBE (Ref # 92170A)	92170-1834	2
TUBE,7X12X700 (Ref # 92192A)	92192-0778	2