

# 2021 KLX®300 PARTS DIAGRAM

Throttle

E1510

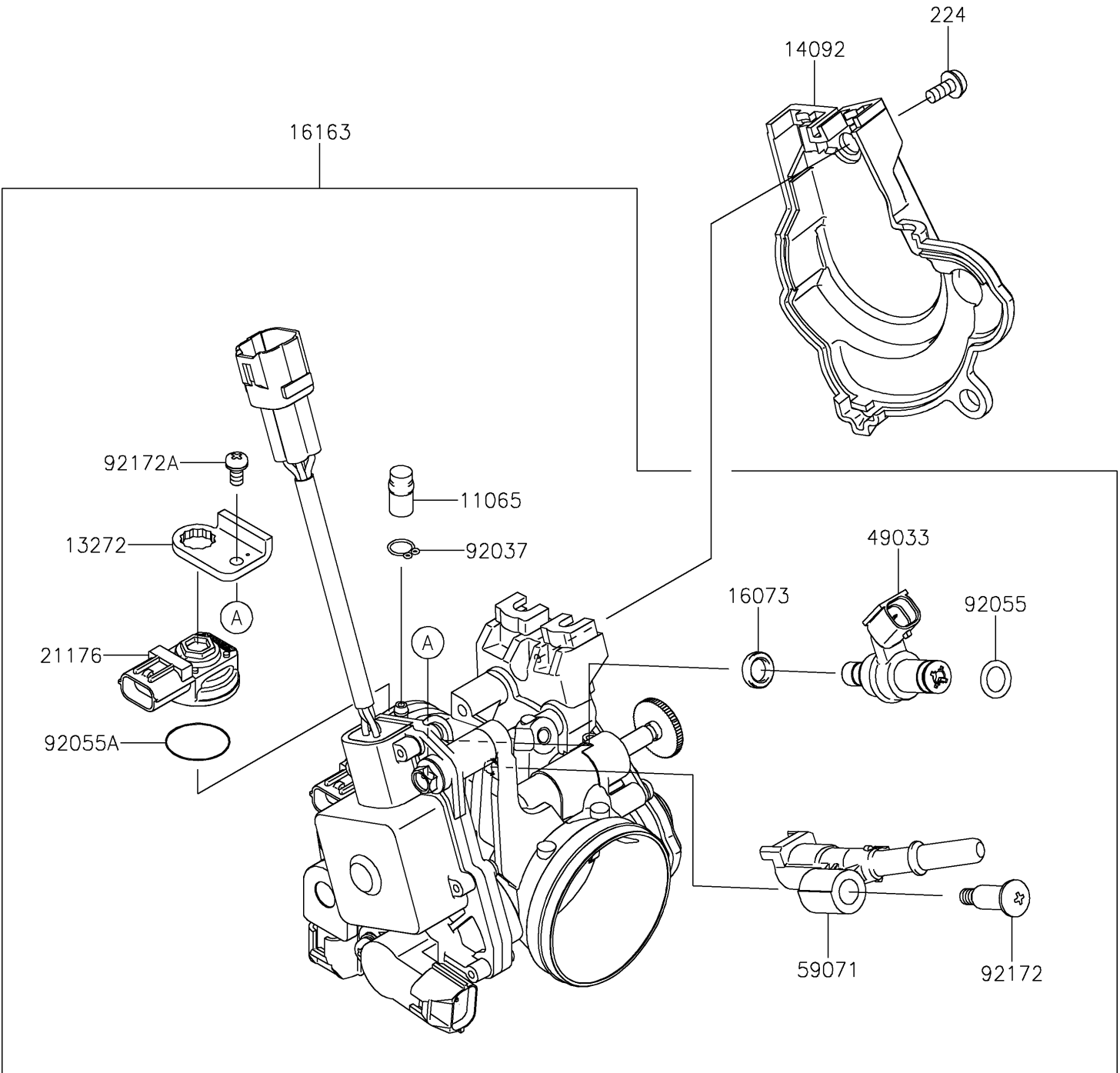

# 2021 KLX®300 PARTS LIST

Throttle

ITEM NAME	PART NUMBER	QUANTITY
-----------	-------------	----------