

1999 Vulcan 1500 Nomad PARTS DIAGRAM

Crankcase Bolt Pattern

E1412

RH (Out Side)

92150A

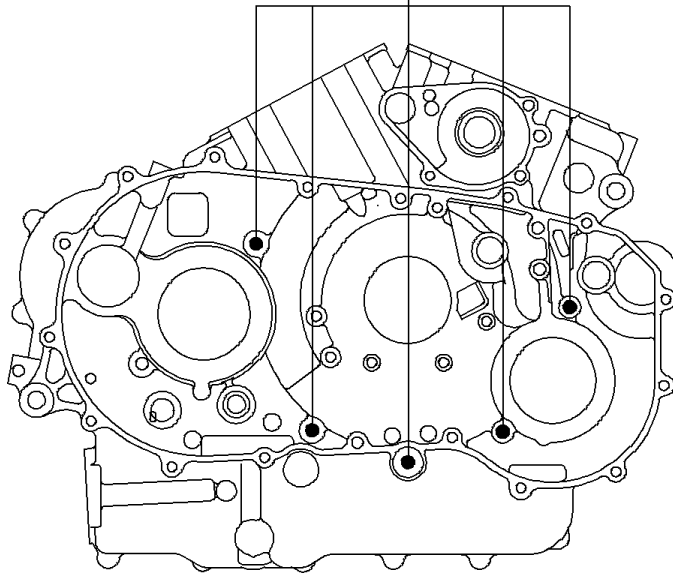

LH (Out Side)

92150

92150A

92150

92002A

92002

1999 Vulcan 1500 Nomad PARTS LIST

Crankcase Bolt Pattern

ITEM NAME	PART NUMBER	QUANTITY
BOLT,6X40 (Ref # 92002)	92002-1566	5
BOLT,6X80 (Ref # 92002A)	92002-1568	3
BOLT,6X70 (Ref # 92150)	92150-1995	6
BOLT,8X90 (Ref # 92150A)	92150-1996	6