

2001 Vulcan 1500 Nomad Fi PARTS DIAGRAM

Ignition System

E1830

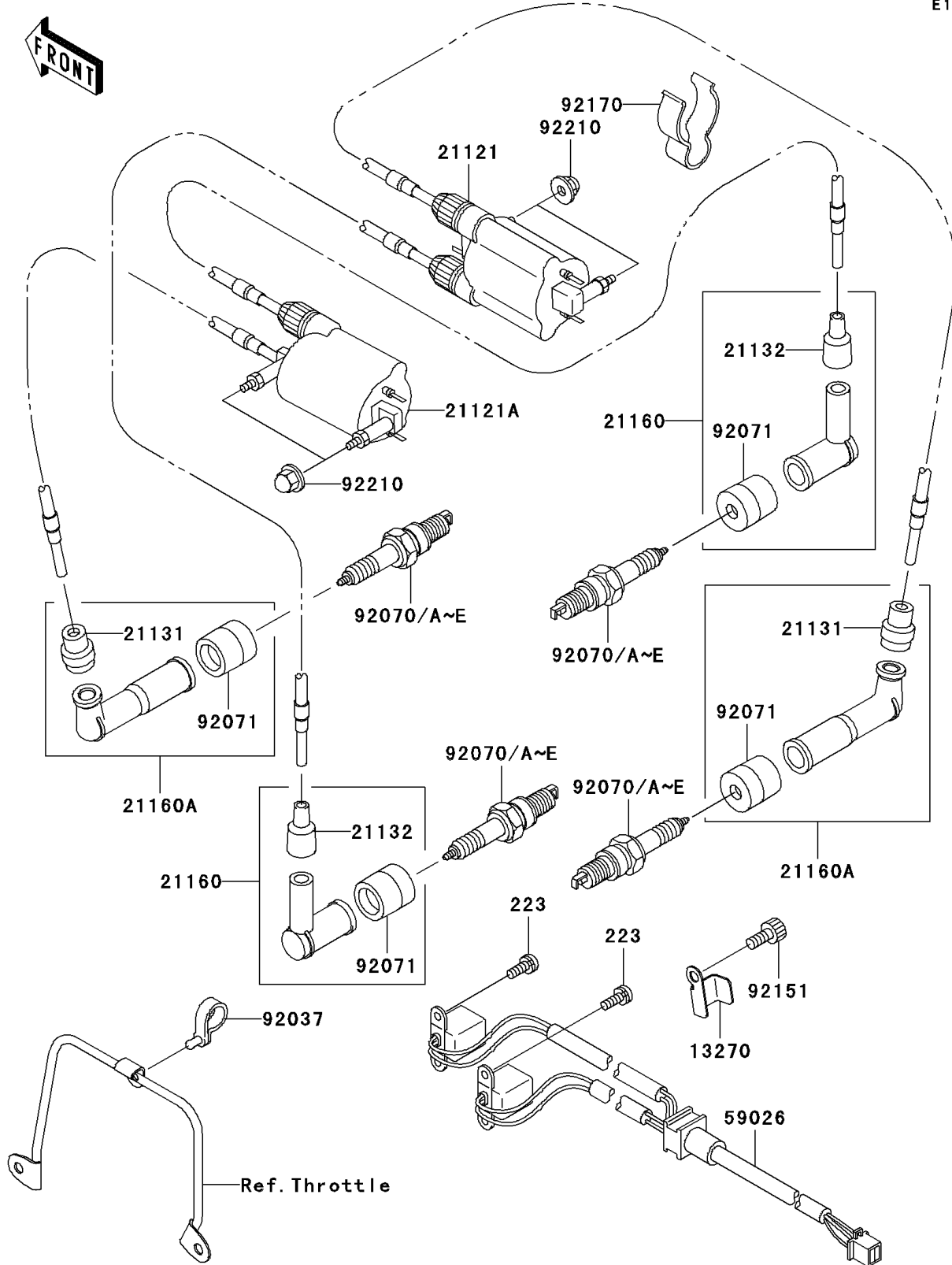

2001 Vulcan 1500 Nomad Fi PARTS LIST

Ignition System

ITEM NAME	PART NUMBER	QUANTITY
SCREW-PAN-WS-CROS (Ref # 223)	223B0516	4
PLATE (Ref # 13270)	13270-1979	1
COIL-IGNITION,RR (Ref # 21121)	21121-1288	1
COIL-IGNITION,FR (Ref # 21121A)	21121-1289	1
GROMMET,HIGH TENSION (Ref # 21131)	21131-005	2
GROMMET,HIGH TENSION (Ref # 21132)	21132-005	2
CAP-ASSY-PLUG (Ref # 21160)	21160-1085	2
CAP-ASSY-PLUG (Ref # 21160A)	21160-1091	2
COIL-PULSING (Ref # 59026)	59026-1157	1
CLAMP,SPEED,L=43 (Ref # 92037)	92037-1290	1
PLUG-SPARK,X22EPR-U9(ND) (Ref # 92070)		AR
PLUG-SPARK,DPR7EA9(NGK) (Ref # 92070A)	92070-1125	AR
PLUG-SPARK,DPR6EA9(NGK) (Ref # 92070B)	92070-1138	4
PLUG-SPARK,X20EPR-U9(ND) (Ref # 92070C)		4
PLUG-SPARK,DPR5EA9(NGK) (Ref # 92070D)	92070-1250	AR
PLUG-SPARK,X16EPR-U9(ND) (Ref # 92070E)		AR
GROMMET,PLUG CAP (Ref # 92071)	92071-1184	4
BOLT,6X10 (Ref # 92151)	92151-3704	1
CLAMP,HOSE (Ref # 92170)	92170-1930	4
NUT,CAP,6MM (Ref # 92210)	92210-0003	4