

2023 Z H2 PARTS DIAGRAM

Clutch

E1350

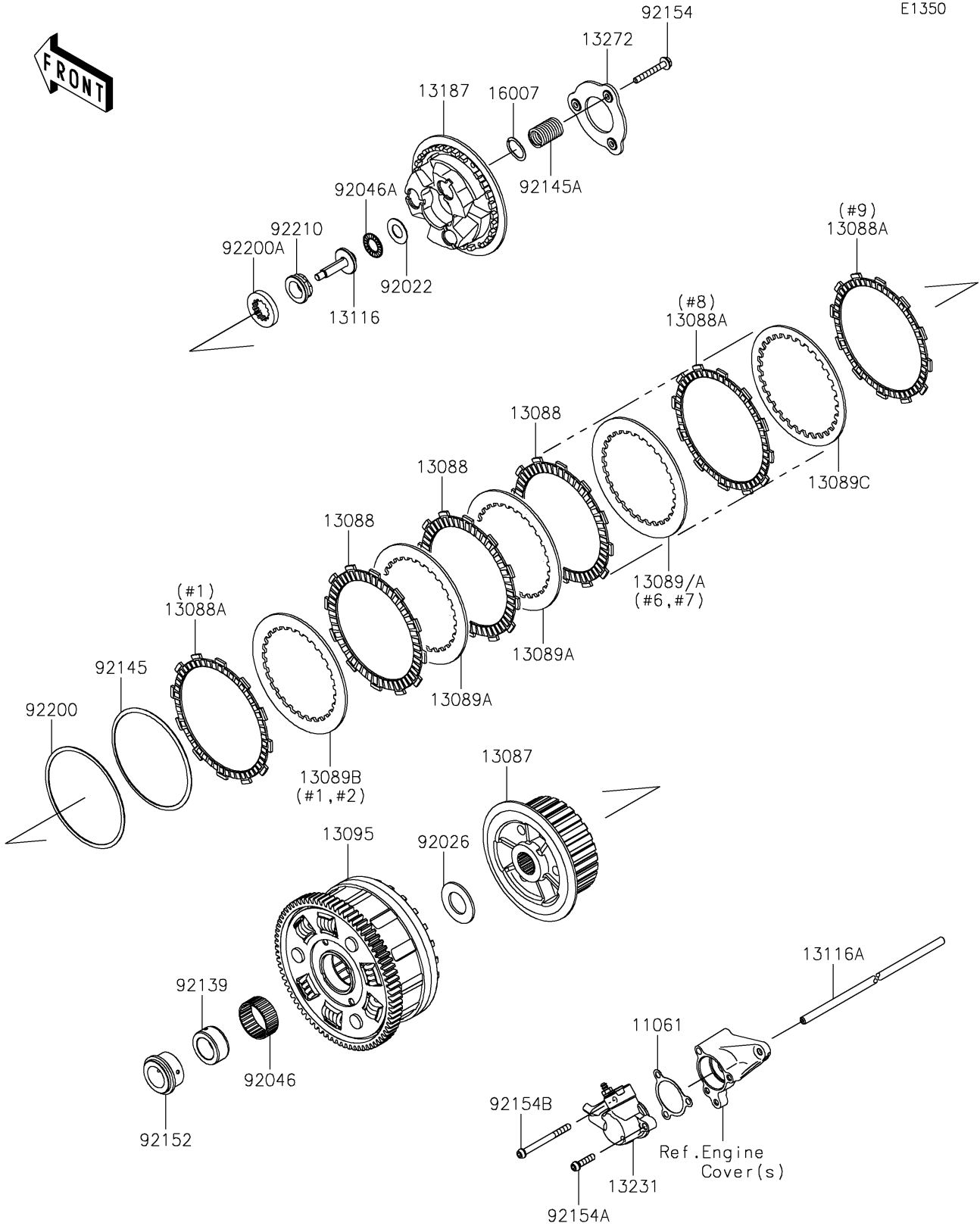

2023 Z H2 PARTS LIST

Clutch

ITEM NAME	PART NUMBER	QUANTITY
GASKET,CLUTCH RELEASE (Ref # 11061)	11061-1259	1
HUB-CLUTCH (Ref # 13087)	13087-0591	1
PLATE-FRICTION (Ref # 13088)	13088-0575	6
PLATE-FRICTION (Ref # 13088A)	13088-0576	3
PLATE-CLUTCH,T=2.3 (Ref # 13089)	13089-0027	AR
PLATE-CLUTCH,T=2.6 (Ref # 13089A)	13089-0028	5
PLATE-CLUTCH,T=2.9 (Ref # 13089B)	13089-0030	2
PLATE-CLUTCH,T=2.6 (Ref # 13089C)	13089-0036	1
HOUSING-COMP-CLUTCH (Ref # 13095)	13095-0602	1
ROD-PUSH (Ref # 13116)	13116-0732	1
ROD-PUSH (Ref # 13116A)	13116-0747	1
PLATE-CLUTCH OPERATING (Ref # 13187)	13187-0034	1
RELEASE-ASSY-CLUTCH (Ref # 13231)	13231-0009	1
PLATE (Ref # 13272)	13272-1303	1
SEAT-SPRING (Ref # 16007)	16007-0736	3
WASHER,15.1X29X1.0 (Ref # 92022)	92022-1463	1
SPACER,25.5X47X2.5 (Ref # 92026)	92026-022	1
BEARING-NEEDLE (Ref # 92046)	92046-0041	1
BEARING-NEEDLE,AXK1102 (Ref # 92046A)	92046-1052	1
BUSHING,25X38X17.3 (Ref # 92139)	92139-0304	1
SPRING (Ref # 92145)	92145-1250	1
SPRING (Ref # 92145A)	92145-1700	3
COLLAR (Ref # 92152)	92152-0866	1
BOLT,FLANGED,6X45 (Ref # 92154)	92154-1909	3
BOLT,SOCKET,6X25 (Ref # 92154A)	92154-2793	2
BOLT,SOCKET,6X70 (Ref # 92154B)	92154-2794	1
WASHER,T=1.2 (Ref # 92200)	92200-1580	1
WASHER,TOOTHED,38.5X25X6.3 (Ref # 92200A)	92200-1833	1
NUT (Ref # 92210)	92210-0397	1