

2004 Vulcan 1500 Nomad Fi PARTS DIAGRAM

Tires

F2210

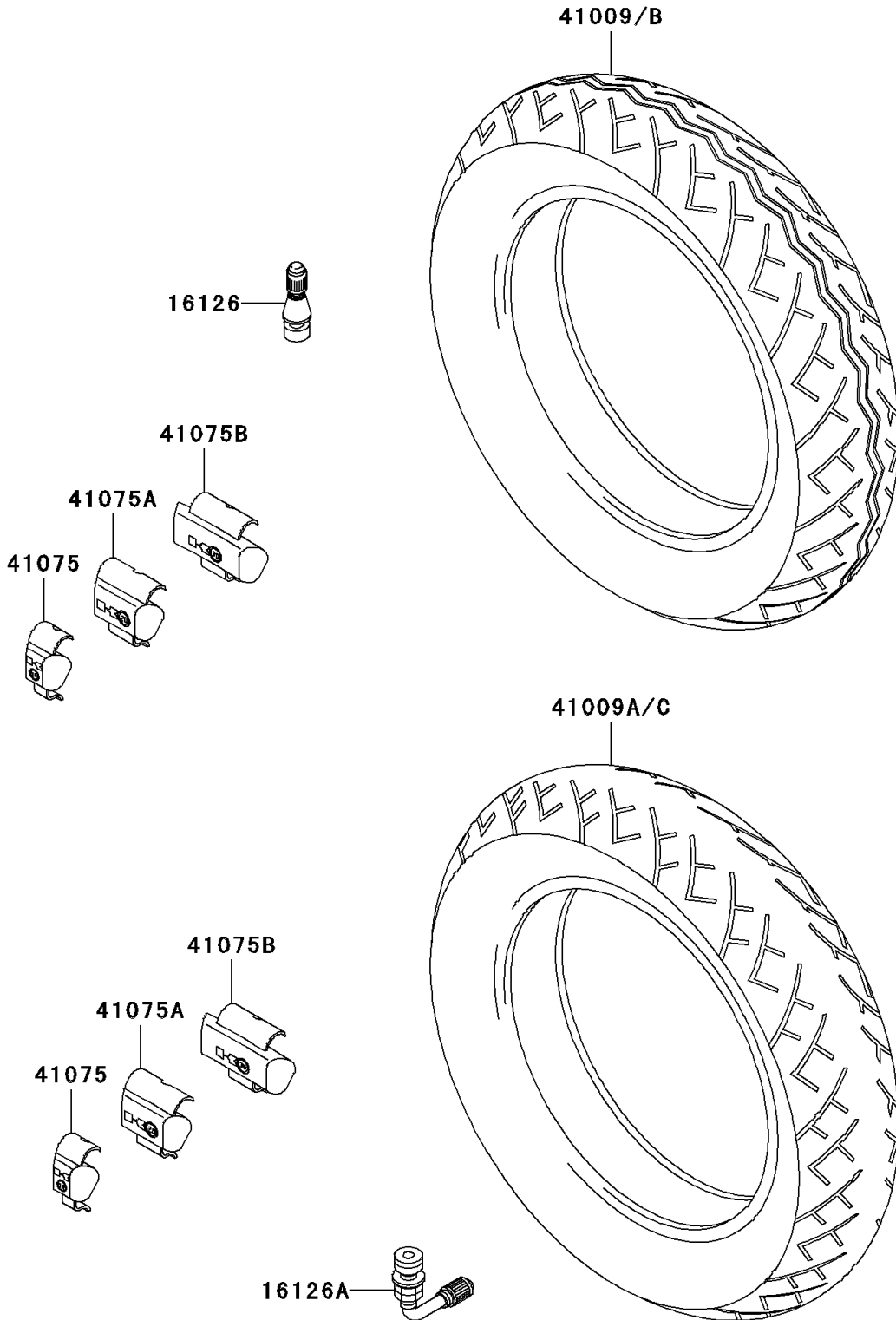

2004 Vulcan 1500 Nomad Fi PARTS LIST

Tires

ITEM NAME	PART NUMBER	QUANTITY
VALVE,TIRE (Ref # 16126)	16126-1140	1
VALVE,TIRE (Ref # 16126A)	16126-1191	1
TIRE,FR,150/80-16 71H,D404FG(D (Ref # 41009)	41009-1275	1
TIRE,RR,150/80B16 71H,D404J(D) (Ref # 41009A)	41009-1276	1
TIRE,FR,150/80-16 71H,G703E(BS (Ref # 41009B)	41009-1296	1
TIRE,RR,150/80B16 71H,G702F(BS (Ref # 41009C)	41009-1406	1
BALANCER-WHEEL,10G,SILVER (Ref # 41075)	41075-1014	AR
BALANCER-WHEEL,20G,SILVER (Ref # 41075A)	41075-1015	AR
BALANCER-WHEEL,30G,SILVER (Ref # 41075B)	41075-1016	AR