

2005 STX-15F PARTS DIAGRAM

Oil Pump

E1710

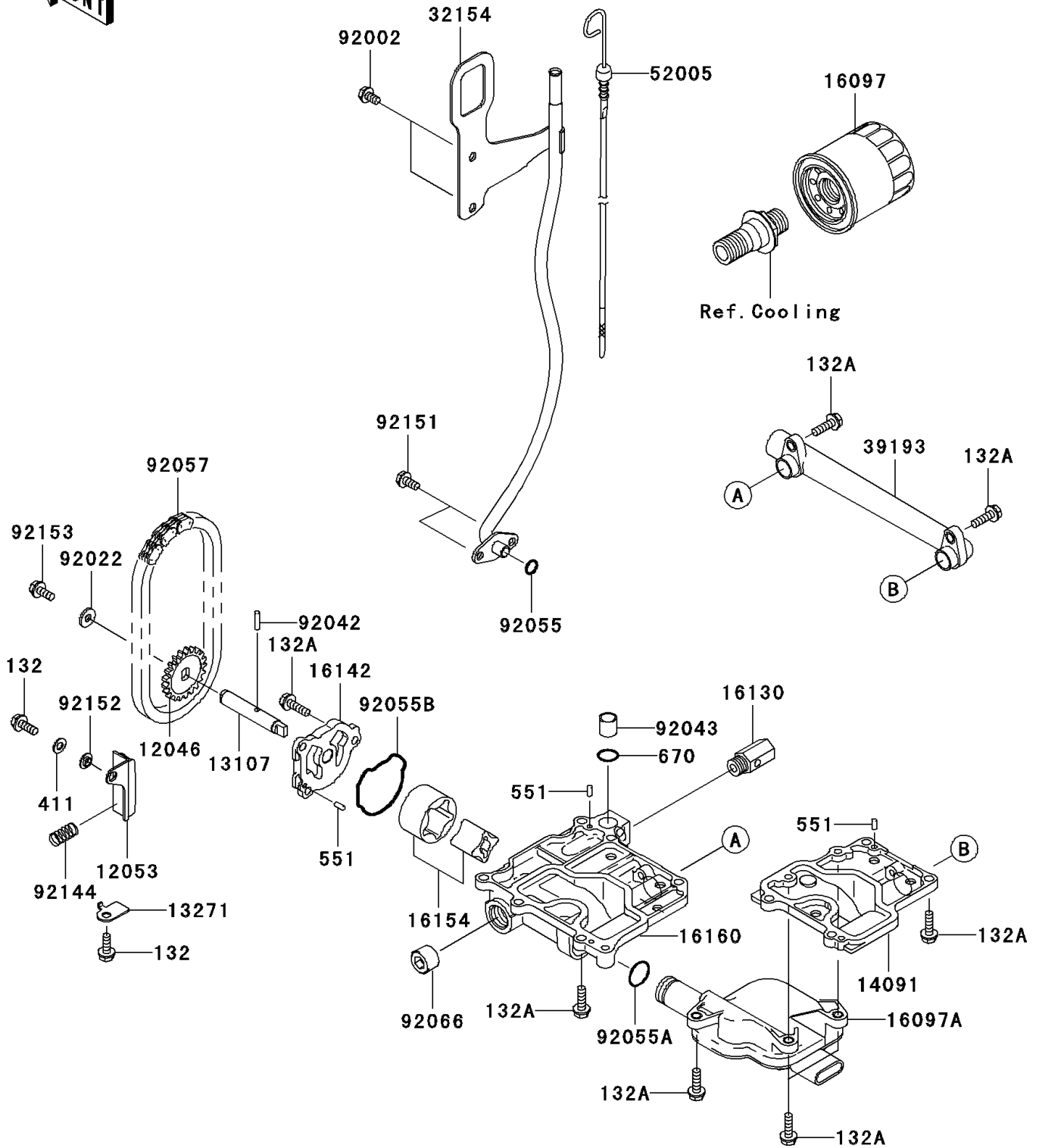

2005 STX-15F PARTS LIST

Oil Pump

ITEM NAME	PART NUMBER	QUANTITY
SPROCKET,23T (Ref # 12046)	12046-3701	1
GUIDE-CHAIN (Ref # 12053)	12053-3704	1
SHAFT (Ref # 13107)	13107-3782	1
PLATE (Ref # 13271)	13271-3850	1
COVER,OIL PUMP (Ref # 14091)	14091-3767	1
FILTER-ASSY-OIL (Ref # 16097)	16097-1072	1
FILTER-ASSY-OIL (Ref # 16097A)	16097-3702	1
VALVE-ASSY-RELIEF (Ref # 16130)	16130-3701	1
COVER-PUMP (Ref # 16142)	16142-3703	1
ROTOR-PUMP (Ref # 16154)	16154-1124	1
BODY,OIL PUMP (Ref # 16160)	16160-3748	1
PIPE,OIL LEVEL (Ref # 32154)	32154-3707	1
PIPE-OIL (Ref # 39193)	39193-3702	1
GAUGE,OIL LEVEL (Ref # 52005)	52005-3709	1
BOLT,6X12 (Ref # 92002)	92002-3763	2
WASHER,6.5X16X2 (Ref # 92022)	92022-1565	1
PIN,DOWEL,4X15.8 (Ref # 92042)	92042-014	1
PIN,11.5X14X14 (Ref # 92043)	92043-1279	1
RING-O,10MM (Ref # 92055)	92055-1150	1
RING-O,19.8X1.9 (Ref # 92055A)	92055-1332	1
RING-O (Ref # 92055B)	92055-3764	1
CHAIN,OIL PUMP (Ref # 92057)	92057-3710	1
PLUG,PT1/2X12.5 (Ref # 92066)	92066-0002	1
SPRING (Ref # 92144)	92144-1551	1
BOLT,6X14 (Ref # 92151)	92151-3788	2
COLLAR,GUIDE (Ref # 92152)	92152-3737	1
BOLT,6X14 (Ref # 92153)	92153-3717	1
BOLT-FLANGED-SMALL (Ref # 132)	132Y0616	2
BOLT-FLANGED-SMALL (Ref # 132A)	132Y0620	18

2005 STX-15F PARTS LIST

Oil Pump

ITEM NAME	PART NUMBER	QUANTITY
WASHER-PLAIN,6MM (Ref # 411)	411S0600	1
PIN-DOWEL (Ref # 551)	551R0408	5
O RING,14MM (Ref # 670)	670D2014	1