

2005 STX-15F PARTS DIAGRAM

Ignition System

E1830

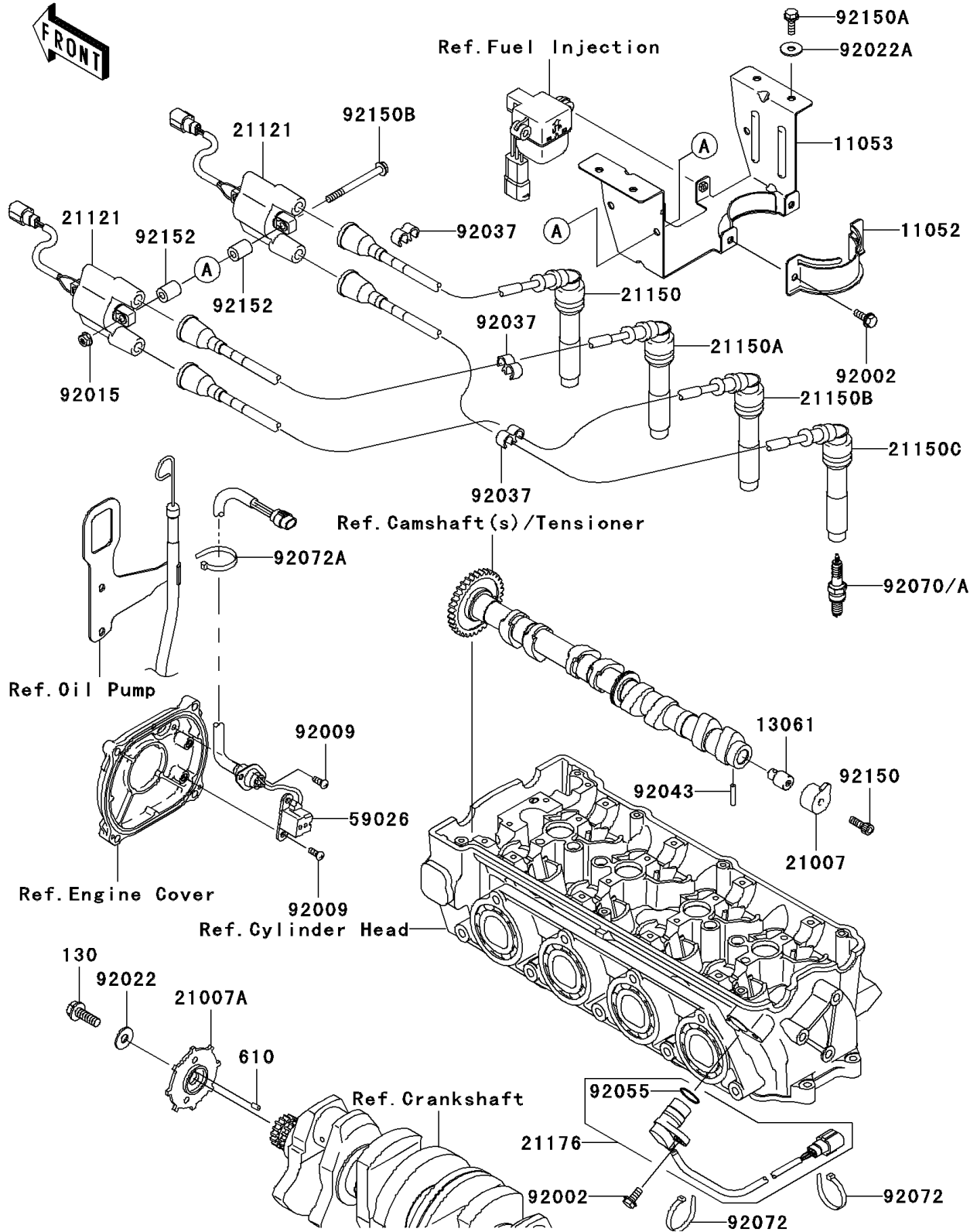

2005 STX-15F PARTS LIST

Ignition System

ITEM NAME	PART NUMBER	QUANTITY
BRACKET,FILTER (Ref # 11052)	11052-3762	1
BRACKET (Ref # 11053)	11053-3783	1
BOSS,CAM SENSOR (Ref # 13061)	13061-1687	1
ROTOR (Ref # 21007)	21007-1356	1
ROTOR,PULSING (Ref # 21007A)	21007-3730	1
COIL-IGNITION (Ref # 21121)	21121-3722	2
CORD-ASSY,#1 (Ref # 21150)	21150-3707	1
CORD-ASSY,#2 (Ref # 21150A)	21150-3708	1
CORD-ASSY,#3 (Ref # 21150B)	21150-3709	1
CORD-ASSY,#4 (Ref # 21150C)	21150-3710	1
SENSOR (Ref # 21176)	21176-1077	1
COIL-PULSING (Ref # 59026)	59026-3702	1
BOLT,6X16 (Ref # 92002)	92002-3728	3
SCREW,5X12 (Ref # 92009)	92009-1296	4
NUT,6MM (Ref # 92015)	92015-3767	2
WASHER,PLAIN (Ref # 92022)	92022-3026	1
WASHER,6.5X20X1.5 (Ref # 92022A)	92022-3710	4
CLAMP,HOSE (Ref # 92037)	92037-1603	3
PIN (Ref # 92043)	92043-1575	1
RING-O (Ref # 92055)	92055-1639	1
PLUG-SPARK,CR9EK(NGK) (Ref # 92070)	92070-1264	4
PLUG-SPARK,CR8EK(NGK) (Ref # 92070A)	92070-1265	4
BAND,L=157 (Ref # 92072)	92072-3873	2
BAND (Ref # 92072A)	92072-3874	1
BOLT,6X18 (Ref # 92150)	92150-1645	1
BOLT,6X18 (Ref # 92150A)	92150-3729	4
BOLT,6X70 (Ref # 92150B)	92150-3753	2
COLLAR (Ref # 92152)	92152-3738	4
BOLT-FLANGED (Ref # 130)	130Z0825	1

2005 STX-15F PARTS LIST

Ignition System

ITEM NAME	PART NUMBER	QUANTITY
ROLLER,4X8 (Ref # 610)	610A0408	1