

2003 Vulcan 1500 Mean Streak PARTS DIAGRAM

Taillight(s)

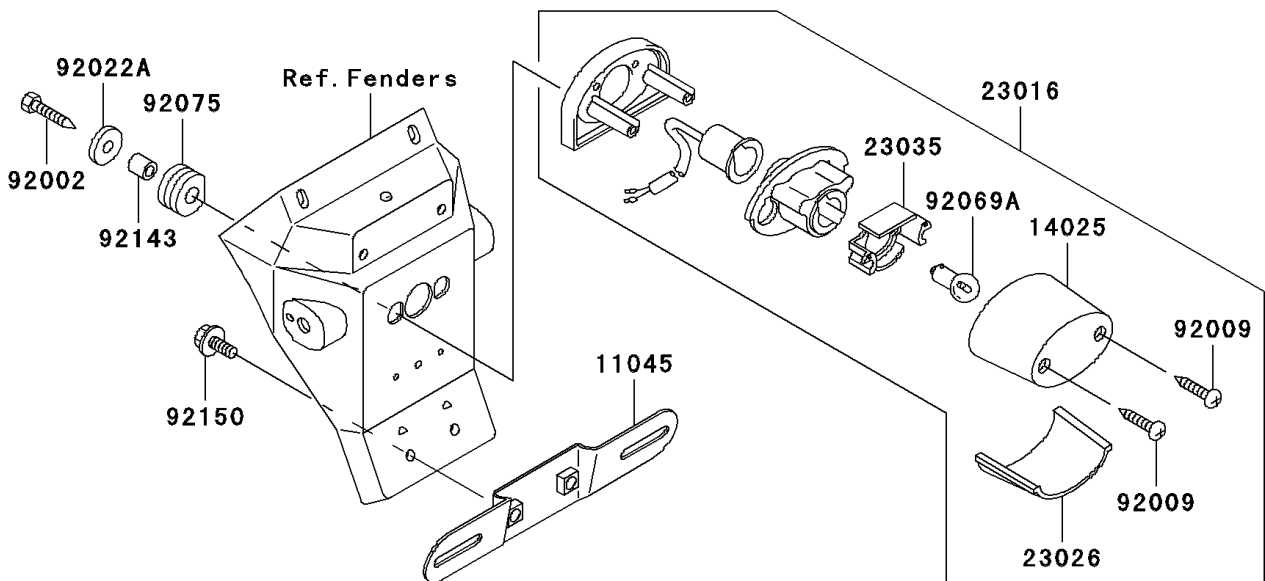
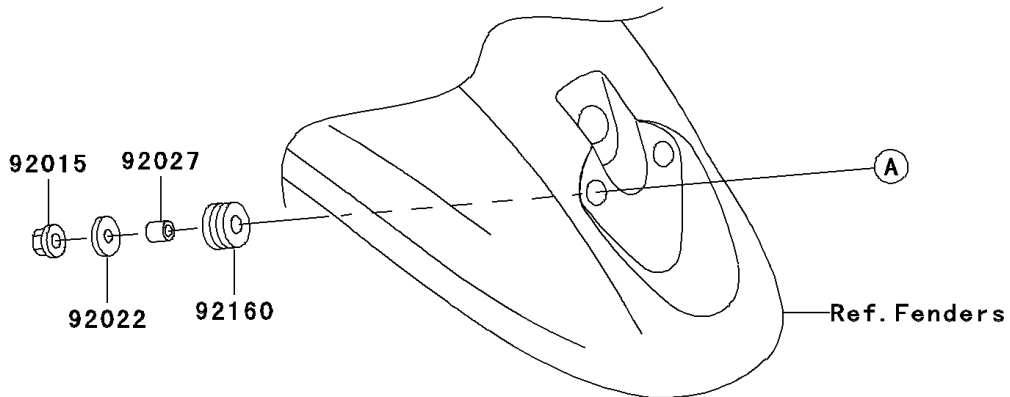
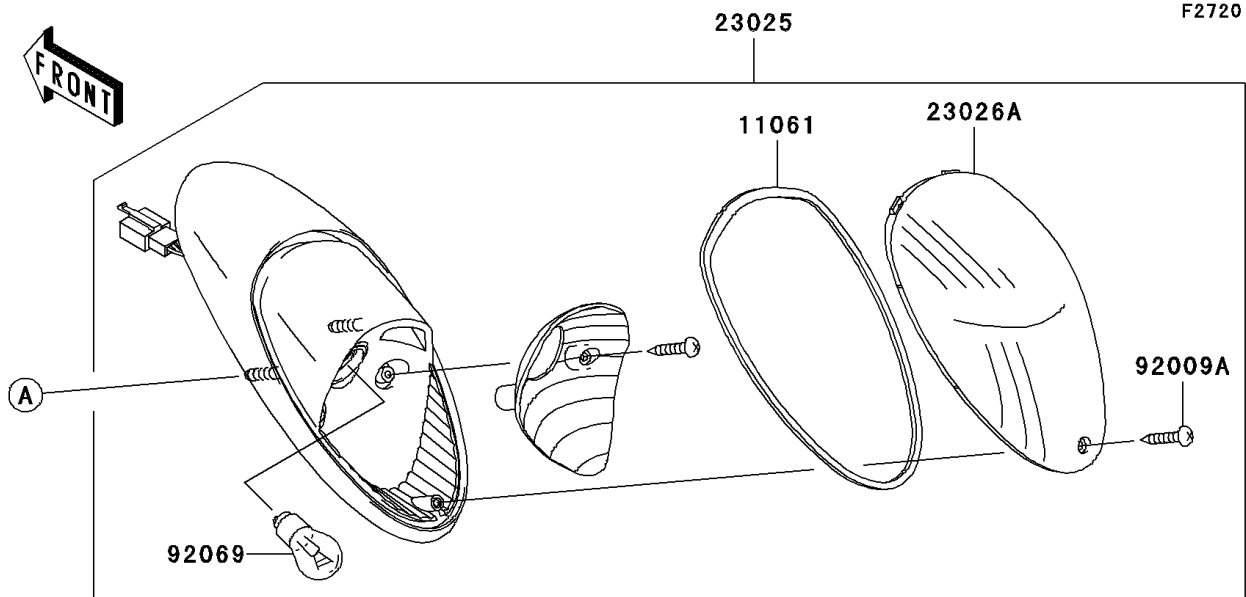

2003 Vulcan 1500 Mean Streak PARTS LIST

Taillight(s)

ITEM NAME	PART NUMBER	QUANTITY
BRACKET,LICENSE (Ref # 11045)	11045-1387	1
GASKET,TAIL LAMP LENS (Ref # 11061)	11061-1089	1
COVER,LICENSE LAMP (Ref # 14025)	14025-1725	1
LAMP-ASSY,LICENSE (Ref # 23016)	23016-1193	1
LAMP-TAIL (Ref # 23025)	23025-1317	1
LENS,LICENSE LAMP (Ref # 23026)	23026-1064	1
LENS,TAIL LAMP (Ref # 23026A)	23026-1246	1
REFLECTOR-LAMP,LICENSE (Ref # 23035)	23035-1060	1
BOLT,TAPPING,5X25 (Ref # 92002)	92002-1831	2
SCREW,TAPPING,4X20 (Ref # 92009)	92009-1378	2
SCREW,TAPPING,4X16 (Ref # 92009A)	92009-1966	1
NUT,FLANGED,6MM (Ref # 92015)	92015-1367	2
WASHER,6.5X20X1.6 (Ref # 92022)	92022-1557	2
WASHER,5.5X20X1.2 (Ref # 92022A)	92022-1581	2
COLLAR,6.8X10X12 (Ref # 92027)	92027-162	2
BULB,12V 21/5W (Ref # 92069)	92069-063	1
BULB,12V 5W (Ref # 92069A)	92069-1055	1
DAMPER (Ref # 92075)	92075-1870	2
COLLAR,5.8X9X10.5 (Ref # 92143)	92143-1047	2
BOLT,6X16 (Ref # 92150)	92150-1909	2
DAMPER (Ref # 92160)	92160-1162	2