

# 2005 Vulcan 1500 Drifter PARTS DIAGRAM

## Frame Fittings

F2131

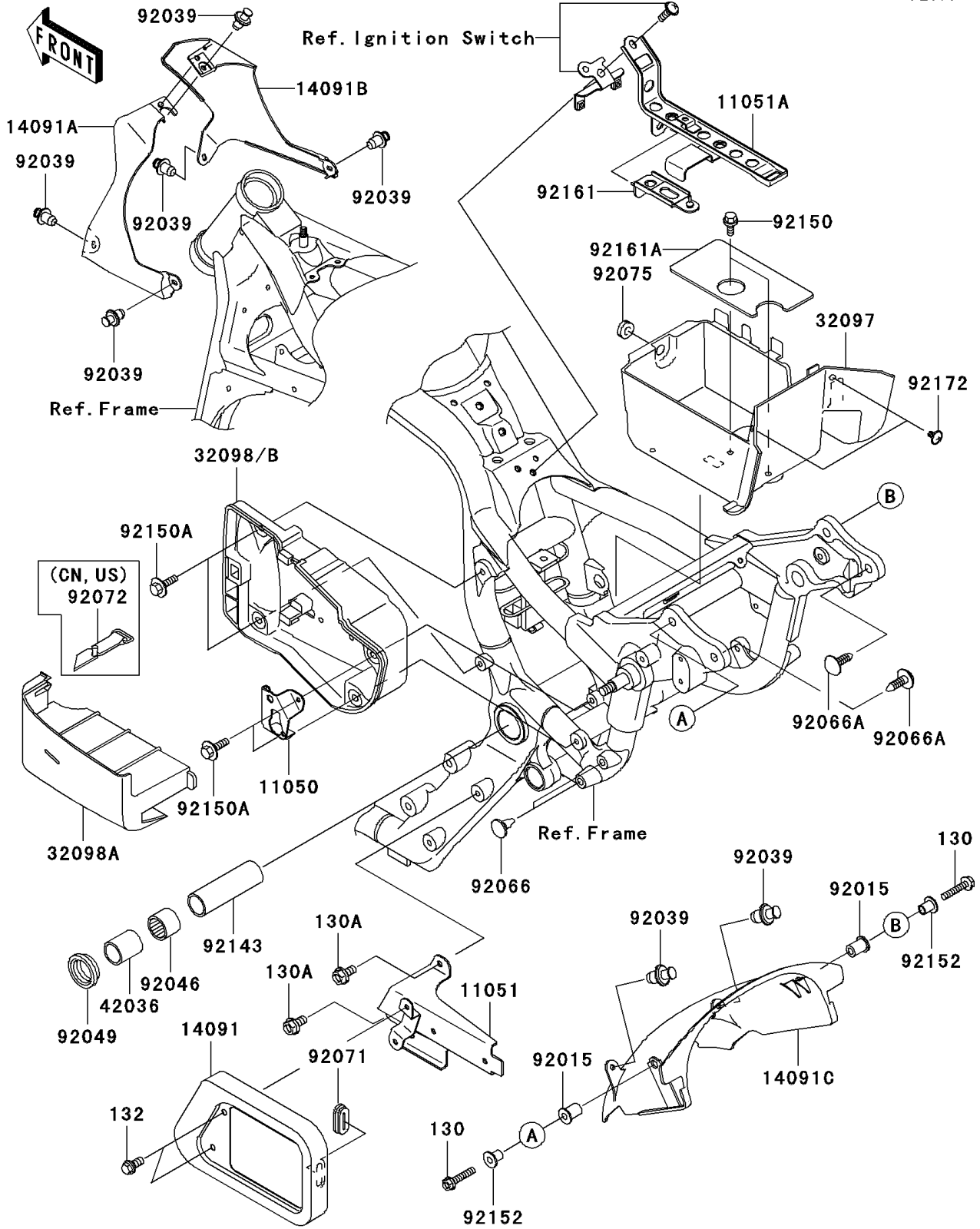

## 2005 Vulcan 1500 Drifter PARTS LIST

### Frame Fittings

ITEM NAME	PART NUMBER	QUANTITY
BOLT-FLANGED (Ref # 130)	130J0525	2
BOLT-FLANGED (Ref # 130A)	130J0612	2
BOLT-FLANGED-SMALL (Ref # 132)	132J0612	2
BRACKET,SIDE COVER LOCK (Ref # 11050)	11050-1958	1
BRACKET,REGULATOR (Ref # 11051)	11051-1163	1
BRACKET,BATTERY BAND (Ref # 11051A)	11051-1798	1
COVER,REGULATOR (Ref # 14091)	14091-1079	1
COVER,HEAD PIPE,LH (Ref # 14091A)	14091-1285	1
COVER,HEAD PIPE,RH (Ref # 14091B)	14091-1286	1
COVER,SEAT UNDER (Ref # 14091C)	14091-1354	1
CASE-BATTERY (Ref # 32097)	32097-1175	1
CASE-TOOL,COVER (Ref # 32098A)	32098-1126	1
SLEEVE,L=45 (Ref # 42036)	42036-1330	2
NUT,WELL,5MM (Ref # 92015)	92015-1757	2
RIVET (Ref # 92039)	92039-1227	7
BEARING-NEEDLE,BM2824 (Ref # 92046)	92046-1202	2
SEAL-OIL (Ref # 92049)	92049-1181	2
PLUG (Ref # 92066)	92066-1103	2
PLUG (Ref # 92066A)	92066-1553	2
GROMMET (Ref # 92071)	92071-0013	1
DAMPER (Ref # 92075)	92075-1067	1
COLLAR,20.2X27X90 (Ref # 92143)	92143-1878	1
BOLT,6X14 (Ref # 92150)	92150-1133	2
BOLT,6X16 (Ref # 92150A)	92150-1198	4
COLLAR (Ref # 92152)	92152-1304	2
DAMPER,BATTERY BAND (Ref # 92161)	92161-1096	1
DAMPER,BATTERY (Ref # 92161A)	92161-1097	1
SCREW,6X10 (Ref # 92172)	92172-0005	2
CASE-TOOL (Ref # 32098)	32098-1125	1

## 2005 Vulcan 1500 Drifter PARTS LIST

### Frame Fittings

ITEM NAME	PART NUMBER	QUANTITY
CASE-TOOL (Ref # 32098B)	32098-1127	1
BAND,L=470 (Ref # 92072)	92072-1331	1