

2006 Vulcan 1600 Classic PARTS DIAGRAM

Seat

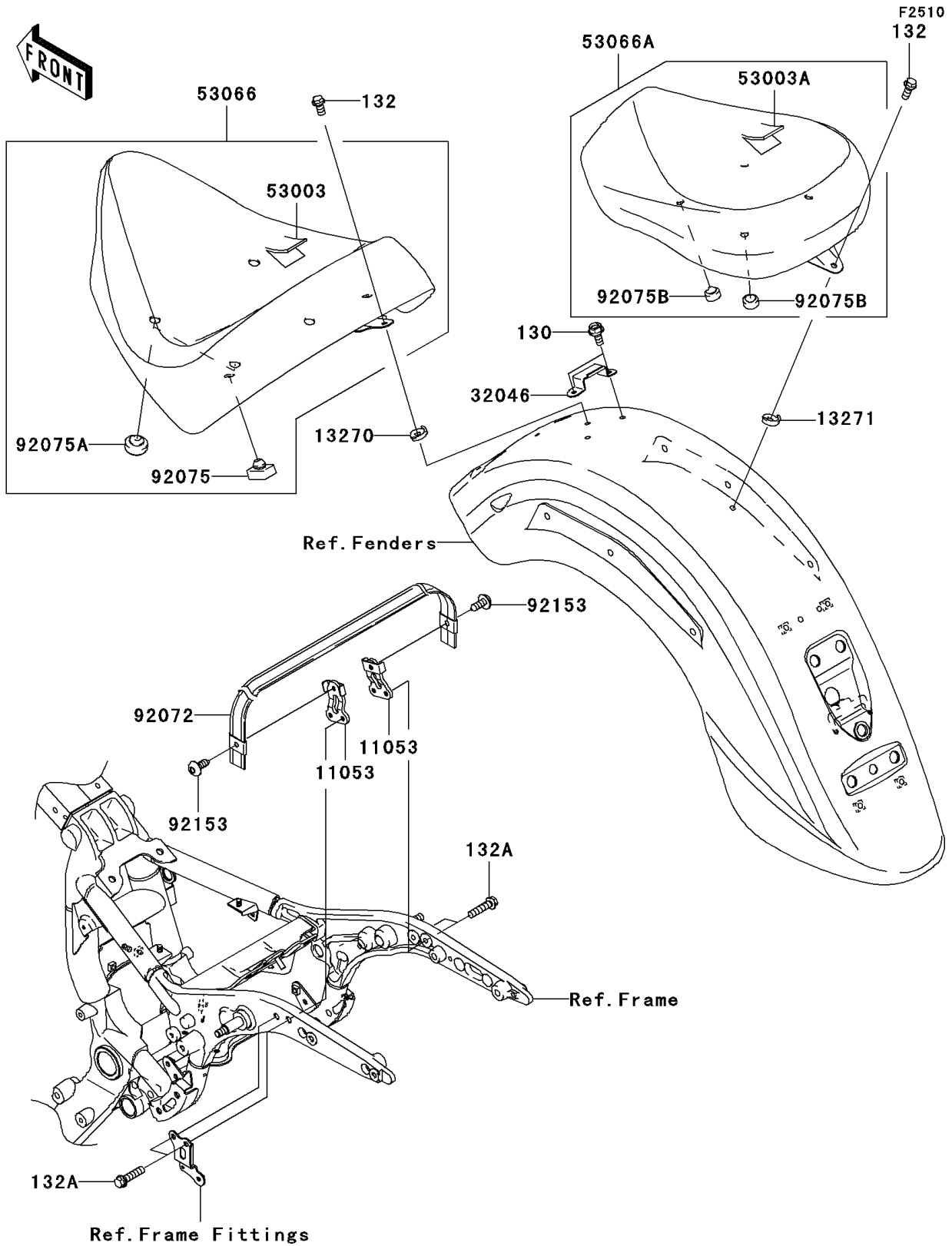

2006 Vulcan 1600 Classic PARTS LIST

Seat

ITEM NAME	PART NUMBER	QUANTITY
BOLT-FLANGED,6X14 (Ref # 130)	130J0614	2
BOLT-FLANGED-SMALL,6X14 (Ref # 132)	132J0614	2
BOLT-FLANGED-SMALL,6X25 (Ref # 132A)	132J0625	4
BRACKET,SEAT BAND (Ref # 11053)	11053-0280	2
PLATE,SEAT (Ref # 13270)	13270-1484	1
PLATE,RR SEAT,RR (Ref # 13271)	13271-0558	1
BRACKET-SEAT (Ref # 32046)	32046-1537	1
LEATHER,FRONT SEAT,BLACK (Ref # 53003)	53003-1531-MA	1
LEATHER,REAR SEAT,BLACK (Ref # 53003A)	53003-1532-MA	1
SEAT-ASSY,FR,BLACK (Ref # 53066)	53066-0020-MA	1
SEAT-ASSY,RR,BLACK (Ref # 53066A)	53066-0089-MA	1
BAND,SEAT (Ref # 92072)	92072-0020	1
DAMPER (Ref # 92075)	92075-099	2
DAMPER (Ref # 92075A)	92075-1045	4
DAMPER (Ref # 92075B)	92075-1927	4
BOLT,SOCKET,6X16 (Ref # 92153)	92153-0374	2