

# 2006 Vulcan 1600 Mean Streak PARTS DIAGRAM

## Front Master Cylinder

F2291

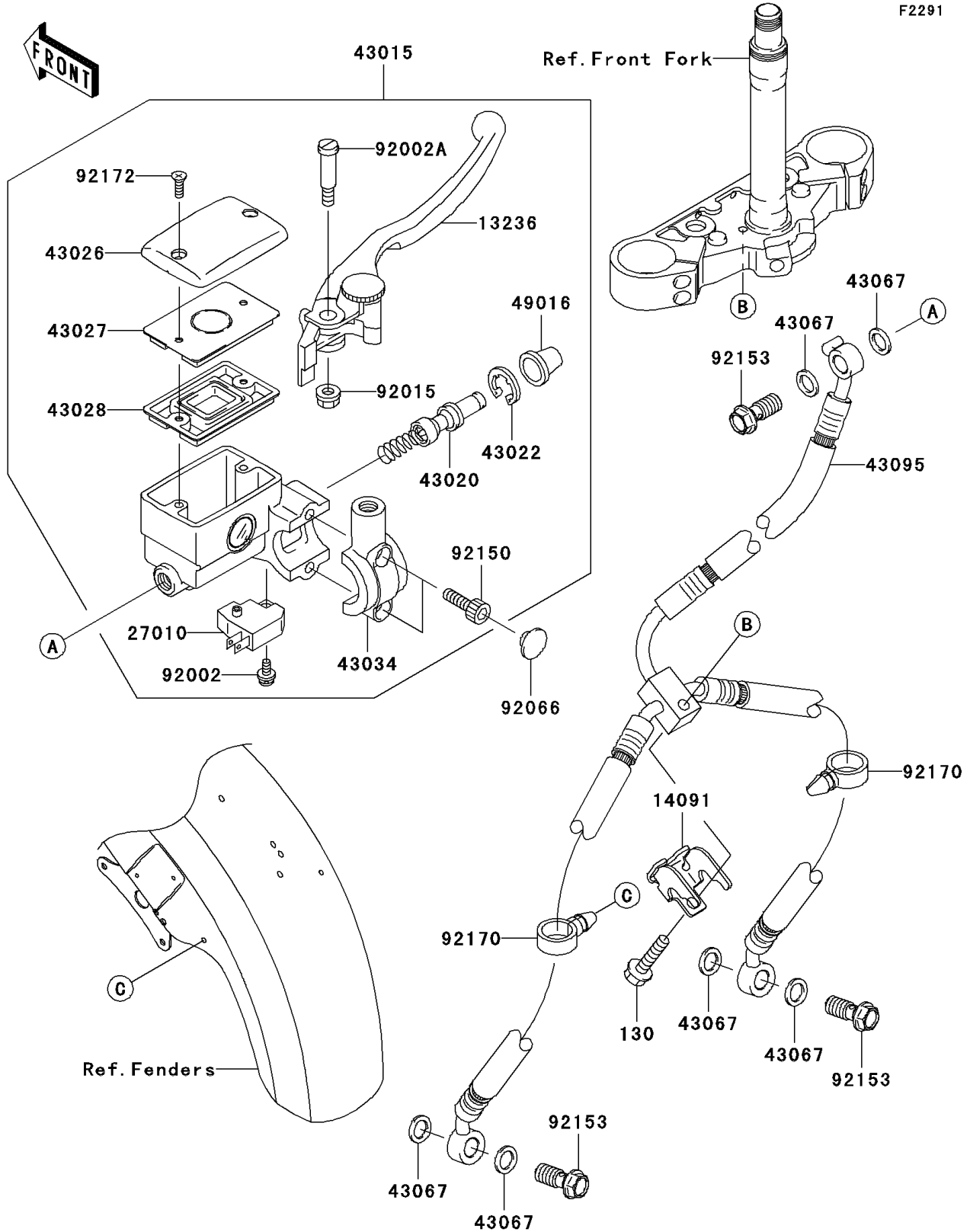

## 2006 Vulcan 1600 Mean Streak PARTS LIST

### Front Master Cylinder

ITEM NAME	PART NUMBER	QUANTITY
BOLT-FLANGED,6X30 (Ref # 130)	130J0630	1
LEVER-COMP,FRONT BRAKE (Ref # 13236)	13236-1315	1
COVER,3 WAY JOINT (Ref # 14091)	14091-1450	1
SWITCH,BRAKE (Ref # 27010)	27010-0025	1
CYLINDER-ASSY-MASTER,FR (Ref # 43015)	43015-0025	1
PISTON-COMP-BRAKE,FR (Ref # 43020)	43020-1054	1
STOPPER-BRAKE,PISTON (Ref # 43022)	43022-1010	1
CAP-BRAKE (Ref # 43026)	43026-0003	1
PLATE-DIAPHRAGM (Ref # 43027)	43027-1059	1
DIAPHRAGM,MASTER CYLINDER (Ref # 43028)	43028-1058	1
HOLDER-BRAKE (Ref # 43034)	43034-1172	1
WASHER,10.5X15X1.5 (Ref # 43067)	43067-001	6
HOSE-BRAKE,FR (Ref # 43095)	43095-0198	1
COVER-SEAL,MASTER CYLINDER (Ref # 49016)	49016-1044	1
BOLT,SCREW,4X12 (Ref # 92002)	92002-1323	1
BOLT,LEVER SET (Ref # 92002A)	92002-1561	1
NUT,FLANGED,6MM (Ref # 92015)	92015-1528	1
PLUG (Ref # 92066)	92066-1301	2
BOLT,SOCKET,6MM (Ref # 92150)	92150-1025	2
BOLT,OIL,L=23 (Ref # 92153)	92153-0627	3
CLAMP (Ref # 92170)	92170-1067	2
SCREW (Ref # 92172)	92172-0083	2