

# 2006 Vulcan 1600 Mean Streak PARTS DIAGRAM

Turn Signals

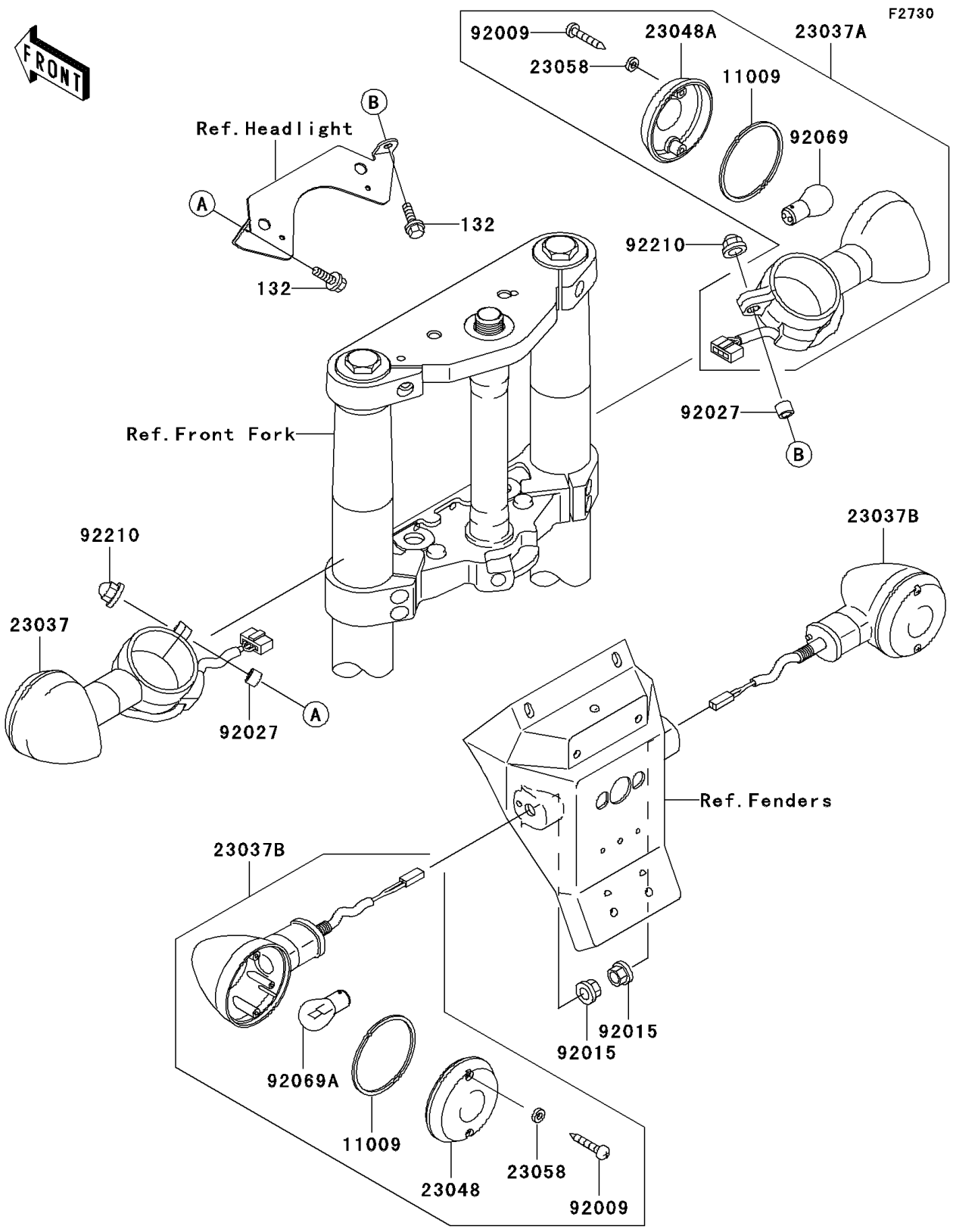

## 2006 Vulcan 1600 Mean Streak PARTS LIST

### Turn Signals

ITEM NAME	PART NUMBER	QUANTITY
BOLT-FLANGED-SMALL,6X20 (Ref # 132)	132E0620	2
GASKET,SIGNAL LAMP (Ref # 11009)	11009-1413	4
LAMP-ASSY-SIGNAL,FR,LH (Ref # 23037)	23037-1405	1
LAMP-ASSY-SIGNAL,FR,RH (Ref # 23037A)	23037-1406	1
LAMP-ASSY-SIGNAL,RR (Ref # 23037B)	23037-1412	2
LENS-SIGNAL LAMP (Ref # 23048)	23048-1065	2
LENS-SIGNAL LAMP (Ref # 23048A)	23048-1066	2
WASHER,PLAIN,4MM (Ref # 23058)	23058-002	8
SCREW,TAPPING,4X25 (Ref # 92009)	92009-1637	8
NUT,10MM (Ref # 92015)	92015-1356	2
COLLAR,6.8X10X12 (Ref # 92027)	92027-162	2
BULB,12V 21/5W (Ref # 92069)	92069-063	2
BULB,12V 21W (Ref # 92069A)		2
NUT,CAP,6MM (Ref # 92210)	92210-0141	2