

2019 NINJA® ZX™ -6R ABS PARTS DIAGRAM

Crankshaft/Piston(s)

E1320

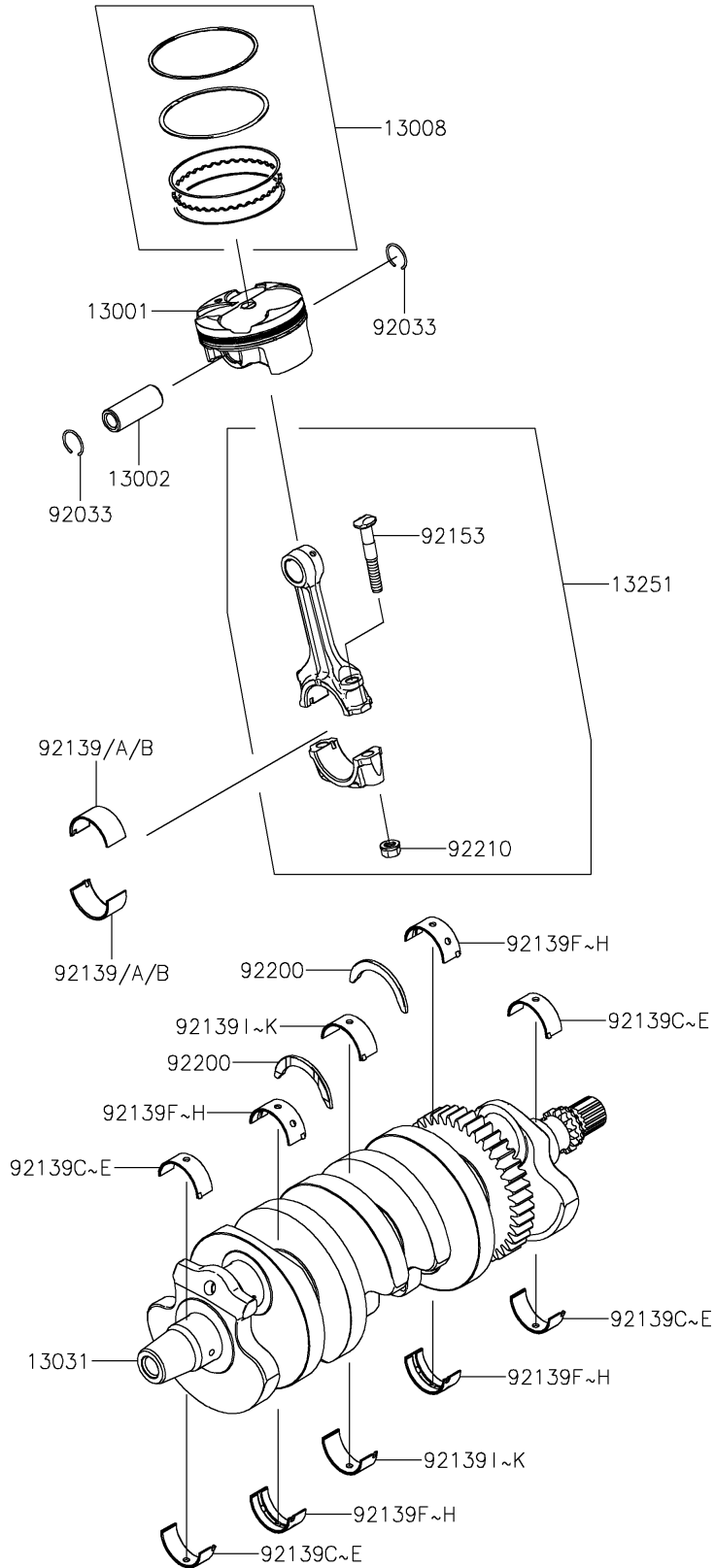

2019 NINJA® ZX™-6R ABS PARTS LIST

Crankshaft/Piston(s)

ITEM NAME	PART NUMBER	QUANTITY
PISTON-ENGINE (Ref # 13001)	13001-0735	4
PIN-PISTON (Ref # 13002)	13002-0037	4
RING-SET-PISTON (Ref # 13008)	13008-0035	4
CRANKSHAFT-COMP (Ref # 13031)	13031-0754	1
ROD-ASSY-CONNECTING,J (Ref # 13251)	13251-0717-JJ	4
RING-SNAP,PISTON PIN (Ref # 92033)	92033-1151	8
BUSHING,CRANK PIN,BLUE (Ref # 92139)	92139-0165	AR
BUSHING,CRANK PIN,BLACK (Ref # 92139A)	92139-0166	8
BUSHING,CRANK PIN,BROWN (Ref # 92139B)	92139-0167	AR
BUSHING,CRANK #1,BLUE (Ref # 92139C)	92139-0245	AR
BUSHING,CRANK #1,BLACK (Ref # 92139D)	92139-0246	4
BUSHING,CRANK #1,BROWN (Ref # 92139E)	92139-0247	AR
BUSHING,CRANK #2,BLUE (Ref # 92139F)	92139-0248	AR
BUSHING,CRANK #2,BLACK (Ref # 92139G)	92139-0249	4
BUSHING,CRANK #2,BROWN (Ref # 92139H)	92139-0250	AR
BUSHING,CRANK #3,PURPLE (Ref # 92139I)	92139-0251	AR
BUSHING,CRANK #3,GREEN (Ref # 92139J)	92139-0252	2
BUSHING,CRANK #3,YELLOW (Ref # 92139K)	92139-0253	AR
BOLT,7MM (Ref # 92153)	92153-1172	8
WASHER,T=2.5 (Ref # 92200)	92200-0383	2
NUT,CONNECTING ROD,7MM (Ref # 92210)	92210-0384	8