

2020 NINJA® ZX™-6R ABS KRT EDITION PARTS DIAGRAM

Engine Cover(s)

E1431

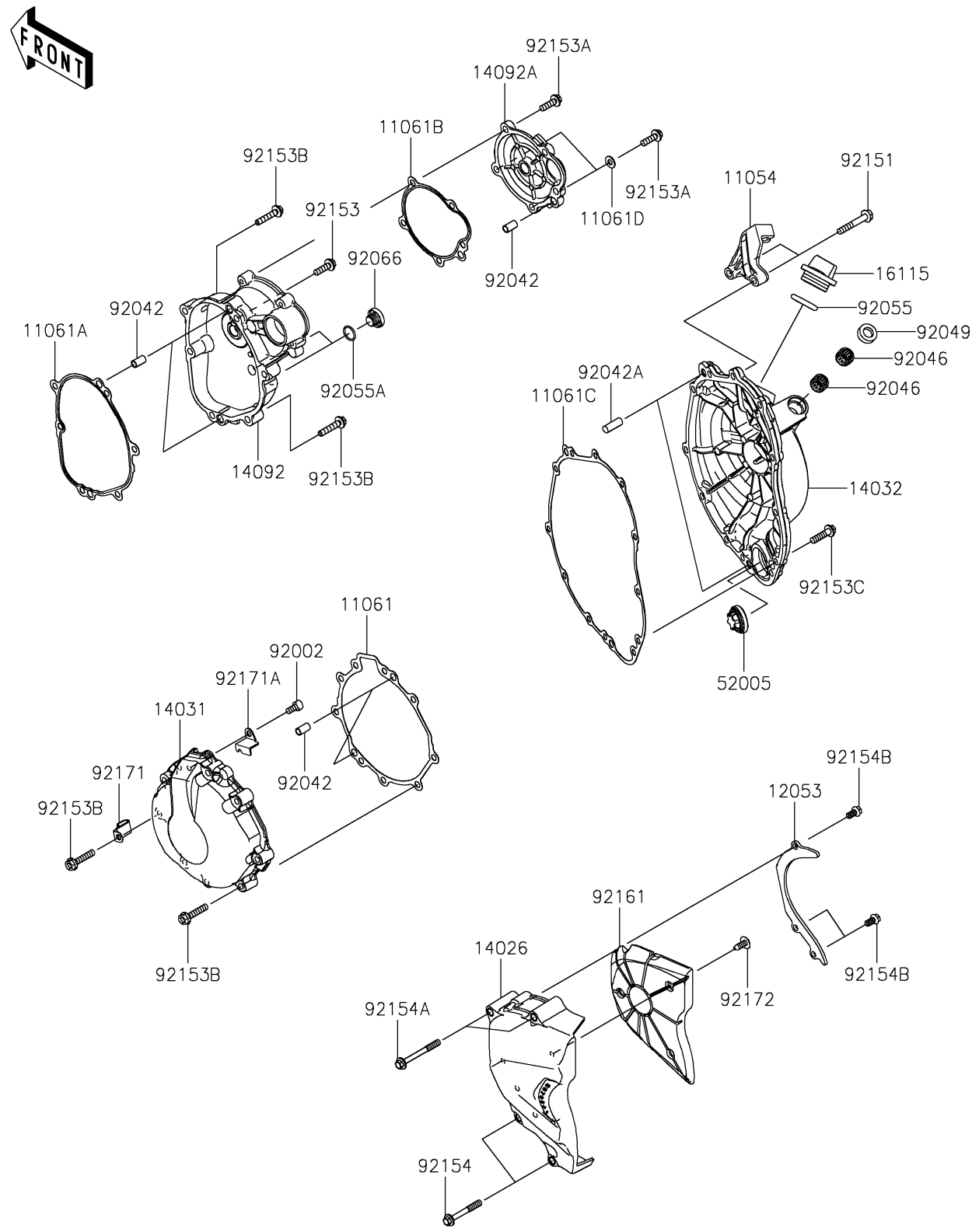

2020 NINJA® ZX™ -6R ABS KRT EDITION PARTS LIST

Engine Cover(s)

ITEM NAME	PART NUMBER	QUANTITY
BRACKET,CLUTCH CABLE HOLDER (Ref # 11054)	11054-1212	1
GASKET,GENERATOR COVER (Ref # 11061)	11061-0249	1
GASKET,LARGE COVER (Ref # 11061A)	11061-0250	1
GASKET,SMALL COVER (Ref # 11061B)	11061-0251	1
GASKET,CLUTCH COVER (Ref # 11061C)	11061-0252	1
GASKET,6.2X13.5X1.0 (Ref # 11061D)	11061-0262	2
GUIDE-CHAIN (Ref # 12053)	12053-0263	1
COVER-CHAIN (Ref # 14026)	14026-0104	1
COVER-GENERATOR (Ref # 14031)	14031-0571	1
COVER-CLUTCH (Ref # 14032)	14032-0572	1
COVER,STARTER,LARGE (Ref # 14092)	14092-0998	1
COVER,STARTER,SMALL (Ref # 14092A)	14092-0999	1
CAP-OIL FILLER (Ref # 16115)	16115-1009	1
GAUGE (Ref # 52005)	52005-1120	1
BOLT,SOCKET,6X12 (Ref # 92002)	92002-1796	1
PIN,DOWEL,6.3X8X14 (Ref # 92042)	92042-007	5
PIN,DOWEL,8X22 (Ref # 92042A)	92042-044	2
BEARING-NEEDLE,HK1210FM (Ref # 92046)	92046-0034	2
SEAL-OIL,CLUTCH RELEASE (Ref # 92049)	92049-1475	1
RING-O,31.5X2.6 (Ref # 92055)	92055-049	1
RING-O,ID=13.8 (Ref # 92055A)	92055-1141	2
PLUG,TIMING HOLE (Ref # 92066)	92066-0067	2
BOLT,FLANGED,6X40 (Ref # 92151)	92151-1583	2
BOLT,FLANGED,6X20 (Ref # 92153)	92153-1010	1
BOLT,FLANGED,6X20 (Ref # 92153A)	92153-1572	5
BOLT,FLANGED,6X30 (Ref # 92153B)	92153-1574	14
BOLT,FLANGED,6X25 (Ref # 92153C)	92153-1716	10
BOLT,FLANGED,6X45 (Ref # 92154)	92154-0102	2
BOLT,FLANGED,6X55 (Ref # 92154A)	92154-0103	2

2020 NINJA® ZX™ -6R ABS KRT EDITION PARTS LIST

Engine Cover(s)

ITEM NAME	PART NUMBER	QUANTITY
BOLT,FLANGED-SMALL,6X12 (Ref # 92154B)	92154-1888	3
DAMPER,CHAIN COVER (Ref # 92161)	92161-1474	1
CLAMP (Ref # 92171)	92171-0761	1
CLAMP (Ref # 92171A)	92171-0938	1
SCREW,6X16 (Ref # 92172)	92172-0284	3