

2020 Ninja® ZX™-6R PARTS DIAGRAM

Accessory(Steering Damper)

F2910C

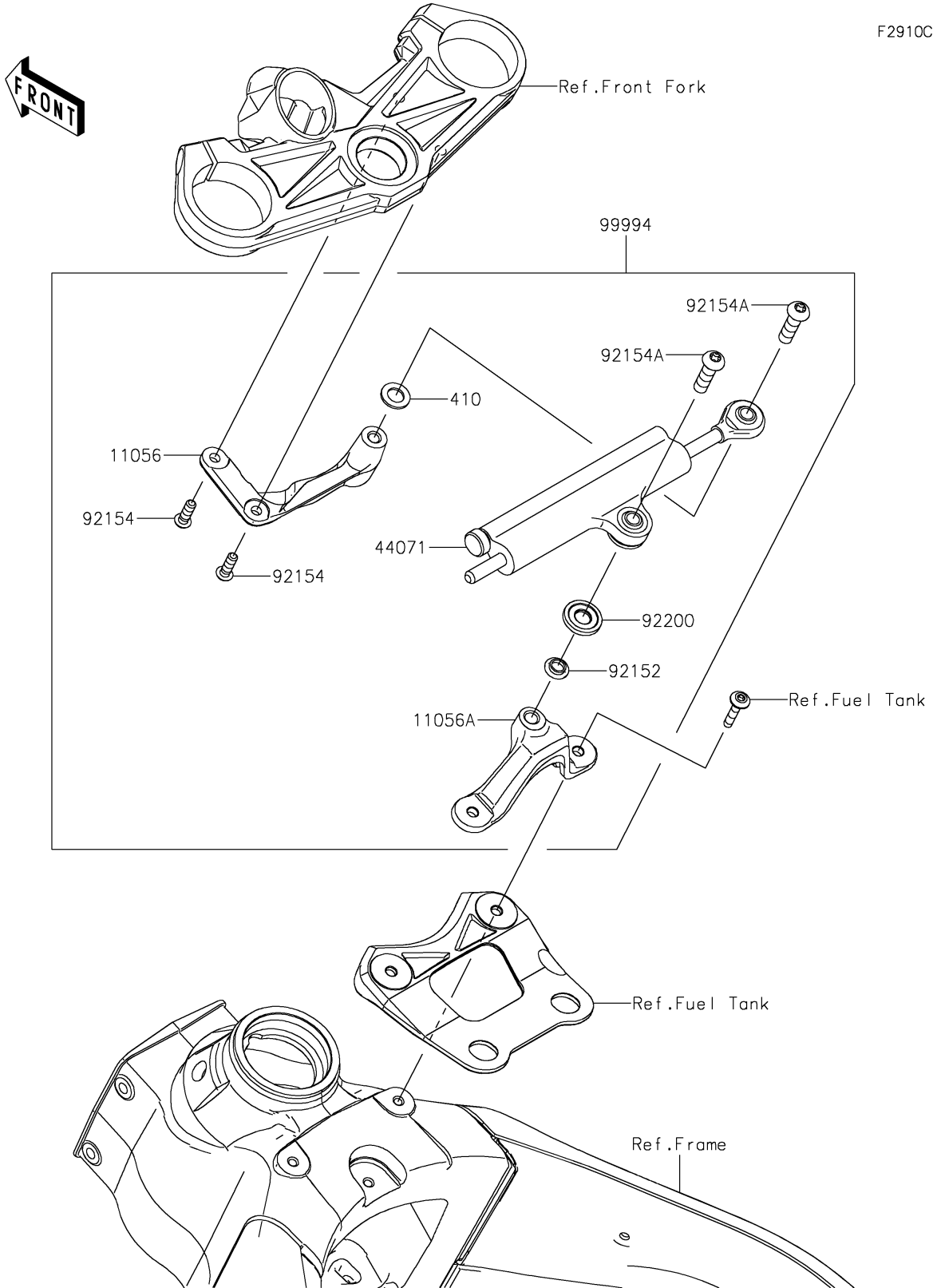

2020 Ninja® ZX™ -6R PARTS LIST

Accessory(Steering Damper)

ITEM NAME	PART NUMBER	QUANTITY
BRACKET (Ref # 11056)	11056-2308	1
BRACKET (Ref # 11056A)	11056-2315	1
DAMPER-ASSY,STEERING (Ref # 44071)	44071-0673	1
COLLAR,L=3.3 (Ref # 92152)	92152-0834	1
BOLT,TORX,6X16 (Ref # 92154)	92154-1188	2
BOLT,TORX,8X25 (Ref # 92154A)	92154-1263	2
WASHER (Ref # 92200)	92200-0293	1
KIT-ACCESSORY,STRG. DAMPER (Ref # 99994)	99994-0350	1
WASHER-PLAIN-SMALL,8MM (Ref # 410)	410AA0800	1