

2007 Vulcan 2000 PARTS DIAGRAM

Crankshaft

E1321

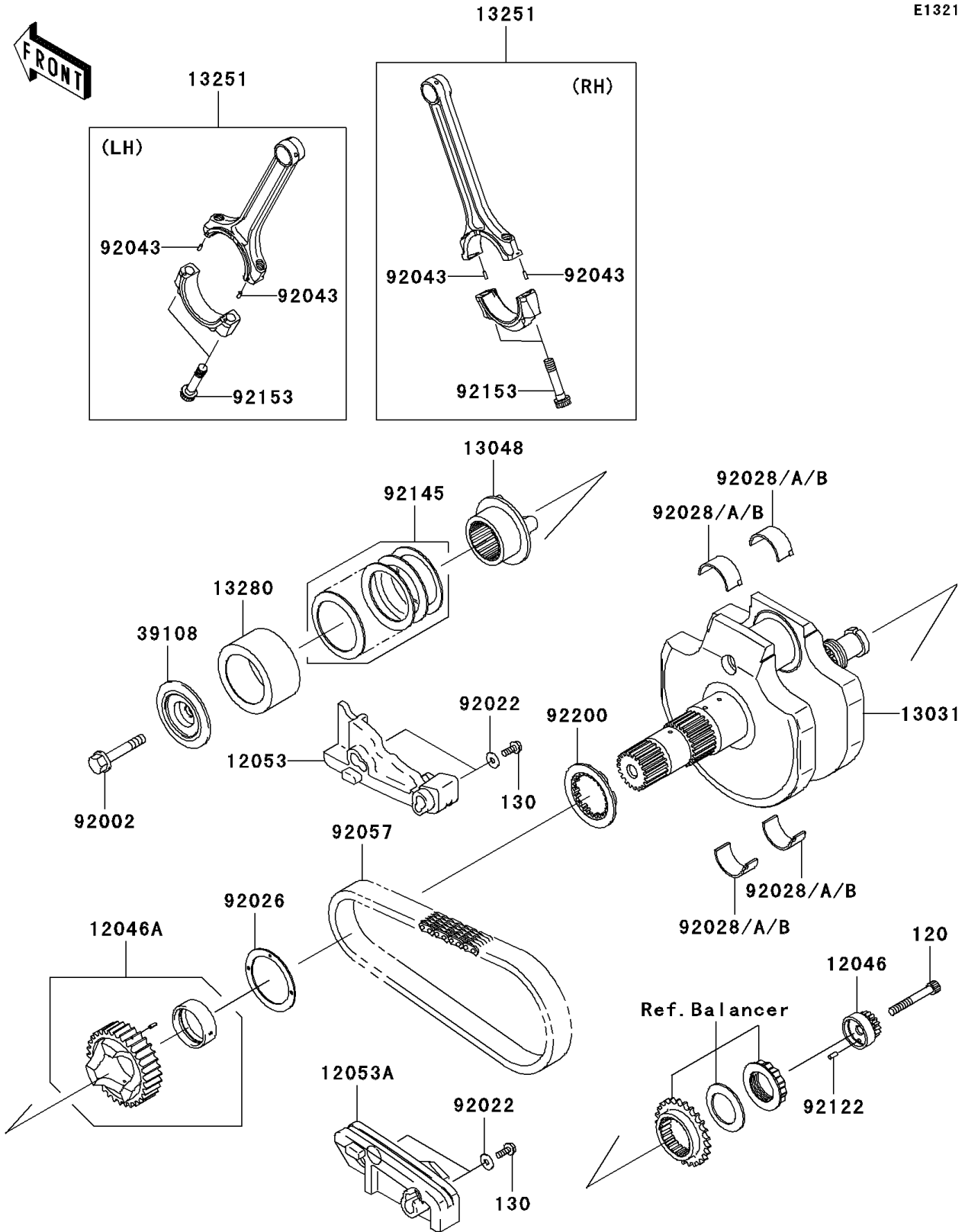

2007 Vulcan 2000 PARTS LIST

Crankshaft

ITEM NAME	PART NUMBER	QUANTITY
BOLT-SOCKET,8X60 (Ref # 120)	120Q0860	1
BOLT-FLANGED,6X16 (Ref # 130)	130P0616	4
SPROCKET,CAM (Ref # 12046)	12046-0005	1
SPROCKET (Ref # 12046A)	12046-0022	1
GUIDE-CHAIN,UPP (Ref # 12053)	12053-0026	1
GUIDE-CHAIN,LWR (Ref # 12053A)	12053-0037	1
CRANKSHAFT-COMP (Ref # 13031)	13031-0031	1
CAM-DAMPER (Ref # 13048)	13048-0001	1
ROD-ASSY-CONNECTING (Ref # 13251)	13251-0001	2
HOLDER (Ref # 13280)	13280-0027	1
RETAINER-SPRING (Ref # 39108)	39108-0002	1
BOLT,FLANGED,12X60 (Ref # 92002)	92002-1464	1
WASHER,6.2X18X1.2 (Ref # 92022)	92022-1369	4
SPACER,57X74X1.97 (Ref # 92026)	92026-0041	1
BUSHING,CONNECTING ROD,BLUE (Ref # 92028)	92028-1474	4
BUSHING,CONNECTING ROD,BLACK (Ref # 92028A)	92028-1475	AR
BUSHING,CONNECTING ROD,BROWN (Ref # 92028B)	92028-1476	AR
PIN,3X8.5 (Ref # 92043)	92043-0033	4
CHAIN,89HV304CF-88 (Ref # 92057)	92057-0027	1
ROLLER,4X9.8 (Ref # 92122)	92122-1197	1
SPRING (Ref # 92145)	92145-0031	1
BOLT,CONNECTING ROD (Ref # 92153)	92153-0314	4
WASHER (Ref # 92200)	92200-0013	1