

2006 Vulcan 2000 PARTS DIAGRAM

Cam Cover(s)

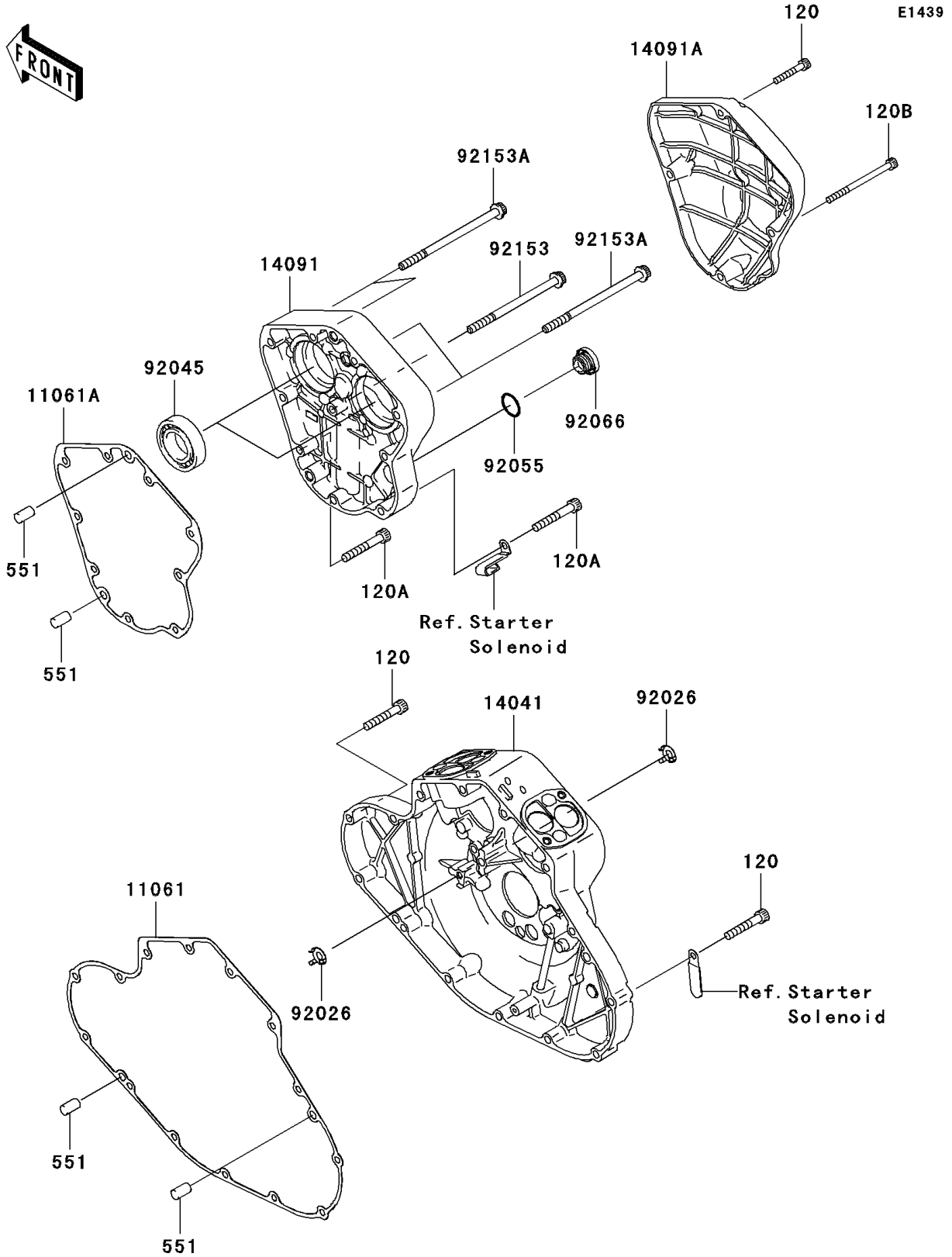

2006 Vulcan 2000 PARTS LIST

Cam Cover(s)

ITEM NAME	PART NUMBER	QUANTITY
BOLT-SOCKET,6X35 (Ref # 120)	120R0635	11
BOLT-SOCKET,6X40 (Ref # 120A)	120R0640	2
BOLT-SOCKET,6X70 (Ref # 120B)	120R0670	3
PIN-DOWEL,8X14 (Ref # 551)	551A0814	4
GASKET,CAM,INSIDE (Ref # 11061)	11061-0019	1
GASKET,CAM,MIDDLE (Ref # 11061A)	11061-0020	1
COVER-COMP (Ref # 14041)	14041-0002	1
COVER,CAM,MIDDLE (Ref # 14091)	14091-0036	1
COVER,CAM (Ref # 14091A)	14091-0165	1
SPACER (Ref # 92026)	92026-0010	2
BEARING-BALL,60/28 (Ref # 92045)	92045-1176	2
RING-O,20X2 (Ref # 92055)	92055-1146	1
PLUG (Ref # 92066)	92066-1456	1
BOLT,6X95 (Ref # 92153)	92153-0320	1
BOLT,6X105 (Ref # 92153A)	92153-0321	4