

2007 Vulcan 2000 PARTS DIAGRAM

Fuel Injection

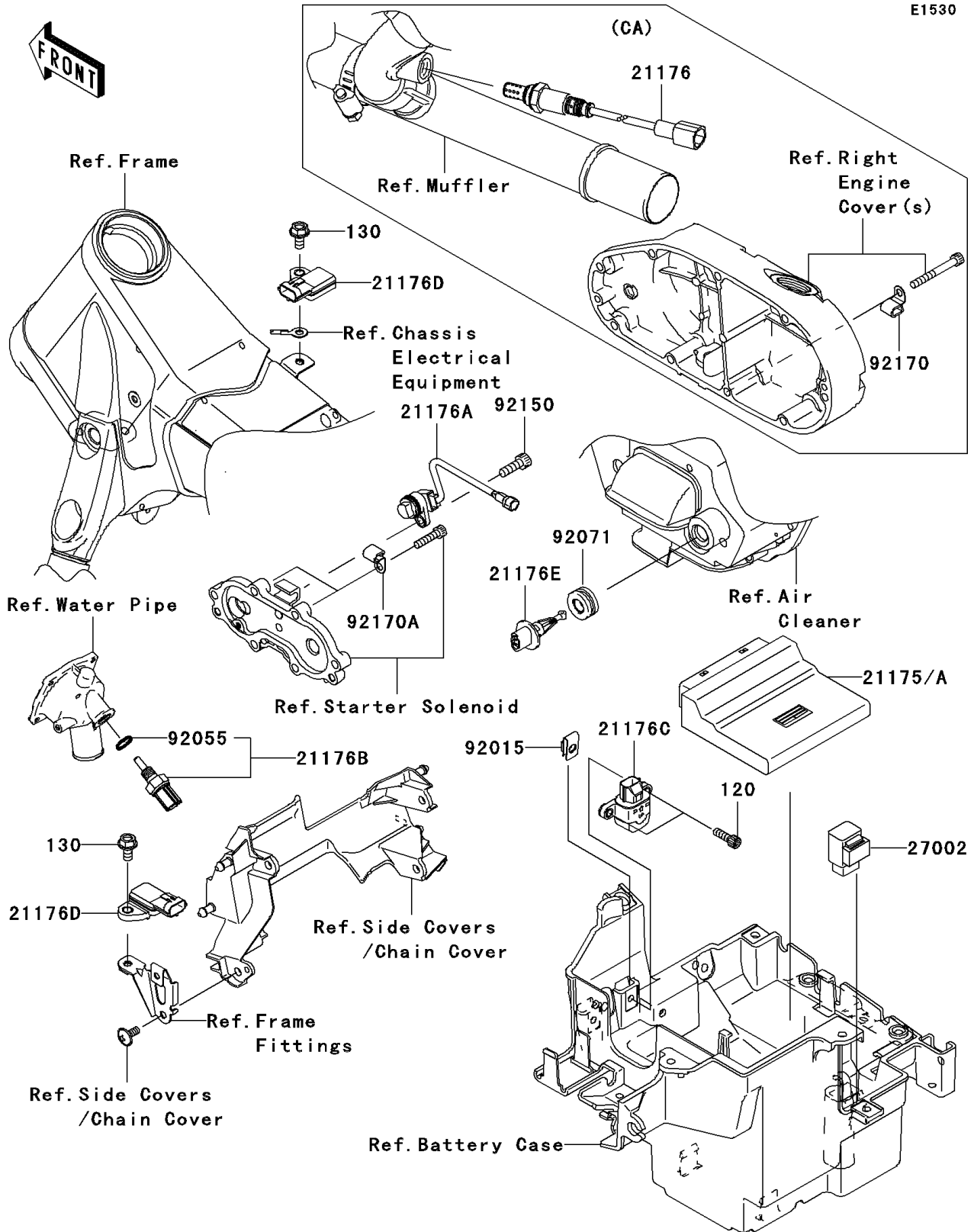

2007 Vulcan 2000 PARTS LIST

Fuel Injection

ITEM NAME	PART NUMBER	QUANTITY
BOLT-SOCKET,5X16 (Ref # 120)	120S0516	2
BOLT-FLANGED,6X12 (Ref # 130)	130L0612	2
SENSOR,CAM ANGLE (Ref # 21176A)	21176-0007	1
SENSOR,WATER TEMP (Ref # 21176B)	21176-0009	1
SENSOR (Ref # 21176C)	21176-0025	1
SENSOR,PRESSURE (Ref # 21176D)	21176-0058	2
SENSOR,AIR TEMP (Ref # 21176E)	21176-2106	1
RELAY-ASSY (Ref # 27002)	27002-1062	1
NUT,5MM (Ref # 92015)	92015-1710	2
RING-O,9.5X1.9 (Ref # 92055)	92055-0016	1
GROMMET (Ref # 92071)	92071-2140	1
BOLT,SOCKET,6X18 (Ref # 92150)	92150-3775	1
CLAMP (Ref # 92170A)	92170-1804	2
CONTROL UNIT-ELECTRONIC (Ref # 21175)	21175-0059	1
CONTROL UNIT-ELECTRONIC (Ref # 21175A)	21175-0060	1
SENSOR,OXYGEN (Ref # 21176)	21176-0005	1
CLAMP (Ref # 92170)	92170-1577	1