

2006 Vulcan 2000 PARTS DIAGRAM

Starter Solenoid

E1842

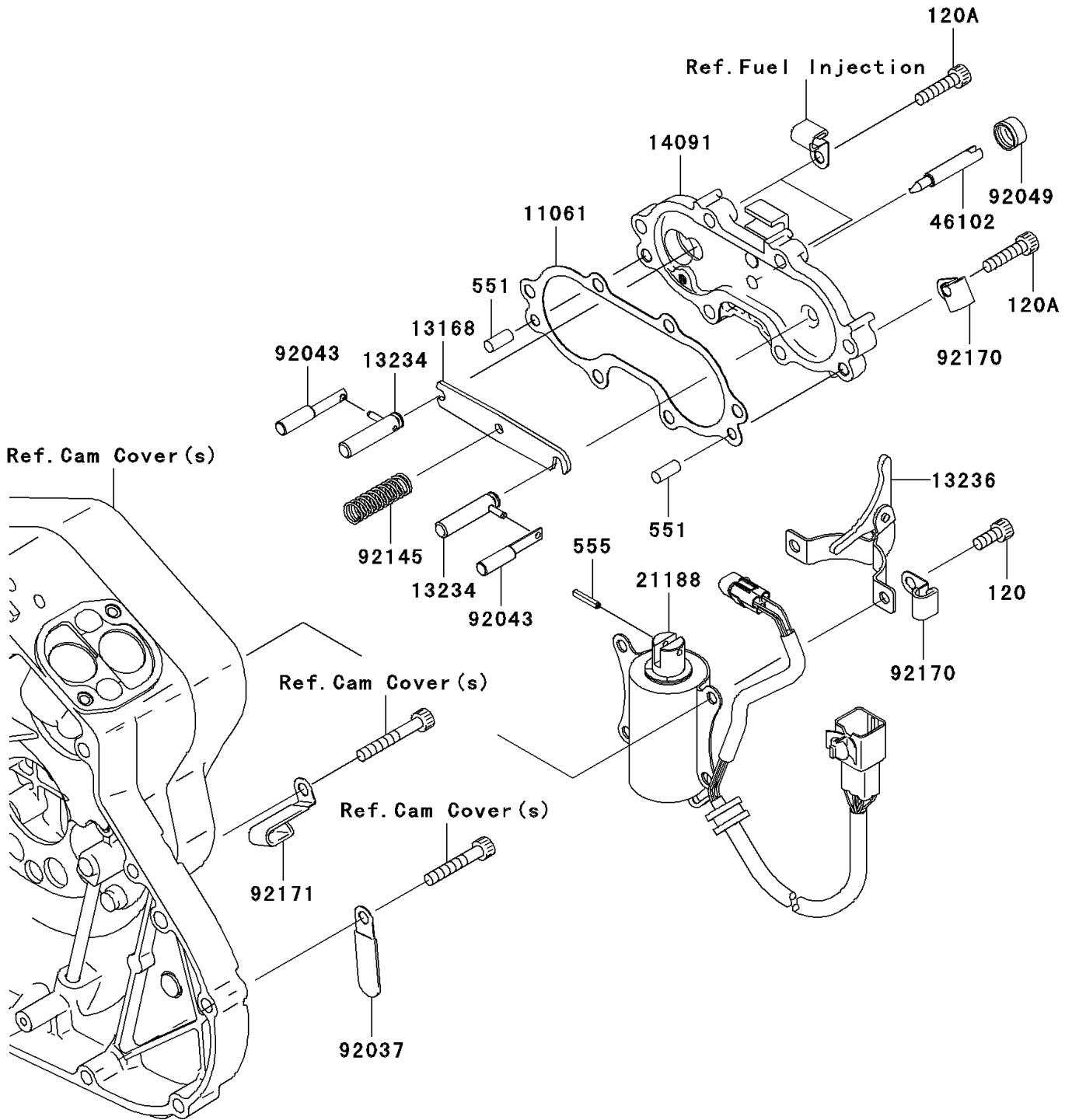

2006 Vulcan 2000 PARTS LIST

Starter Solenoid

ITEM NAME	PART NUMBER	QUANTITY
BOLT-SOCKET,6X14 (Ref # 120)	120R0614	4
BOLT-SOCKET,6X25 (Ref # 120A)	120R0625	6
PIN-DOWEL,6X14 (Ref # 551)	551A0614	2
PIN-SPRING (Ref # 555)	555B0316	1
GASKET (Ref # 11061)	11061-0022	1
LEVER,JOINT (Ref # 13168)	13168-0011	1
SHAFT-COMP (Ref # 13234)	13234-0002	2
LEVER-COMP,SOLENOID (Ref # 13236)	13236-0008	1
COVER (Ref # 14091)	14091-0240	1
SOLENOID (Ref # 21188)	21188-0005	1
ROD,PUSH (Ref # 46102)	46102-0006	1
CLAMP,L=45 (Ref # 92037)	92037-1539	1
PIN,DECOMP (Ref # 92043)	92043-0015	2
SEAL-OIL,RV37129.5 (Ref # 92049)	92049-016	1
SPRING,DECOMP RELEASE (Ref # 92145)	92145-0037	1
CLAMP (Ref # 92170)	92170-1804	2
CLAMP (Ref # 92171)	92171-0322	1