

2023 KX™ 450 PARTS DIAGRAM

Gear Change Mechanism

E1370

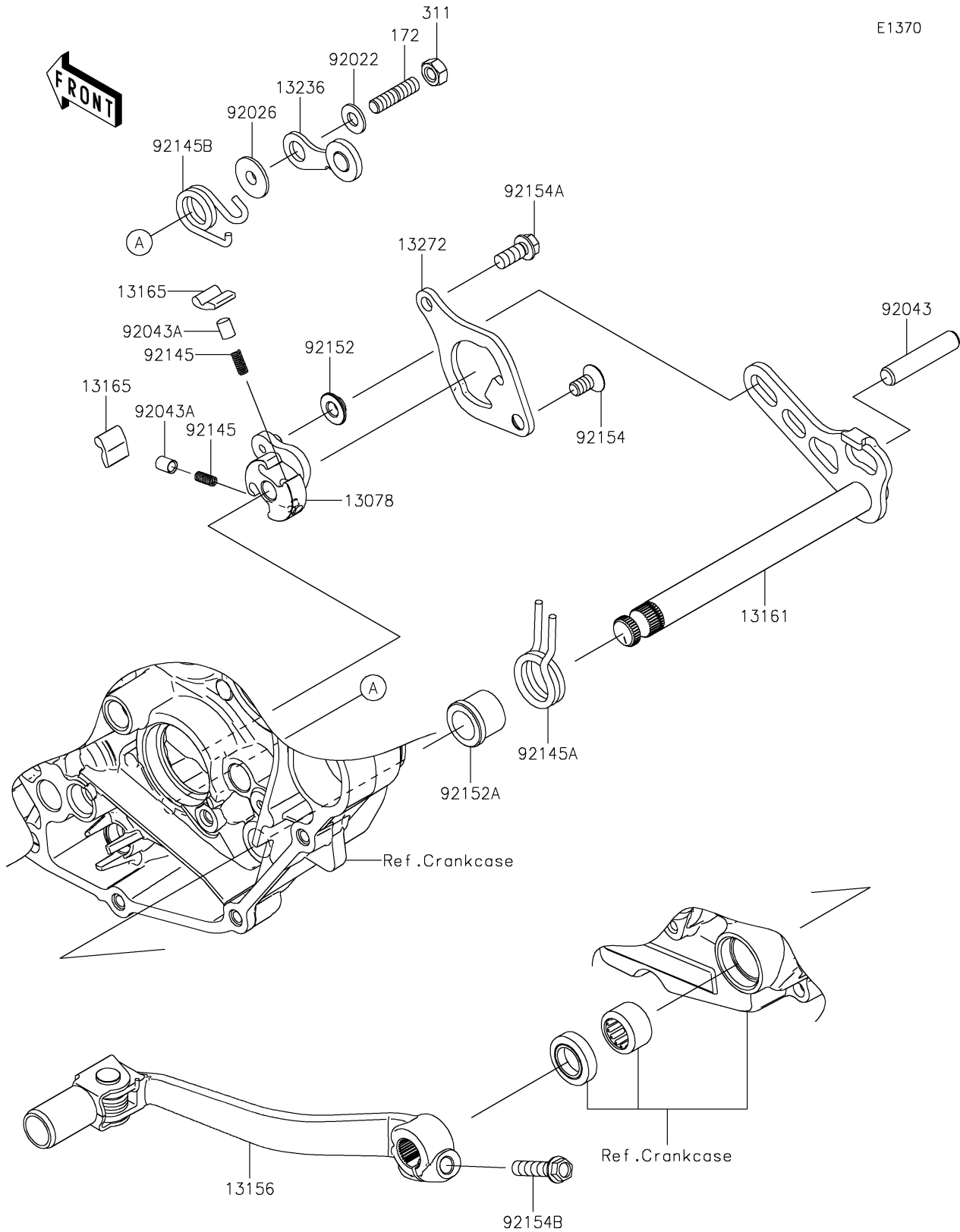

2023 KX™ 450 PARTS LIST

Gear Change Mechanism

ITEM NAME	PART NUMBER	QUANTITY
RATCHET (Ref # 13078)	13078-0029	1
LEVER-CHANGE (Ref # 13156)	13156-0614	1
LEVER-COMP-CHANGE SHAFT (Ref # 13161)	13161-0583	1
PAWL (Ref # 13165)	13165-0018	2
LEVER-COMP (Ref # 13236)	13236-0764	1
PLATE,POLE GUIDE (Ref # 13272)	13272-1940	1
WASHER,6X12.8X1.2 (Ref # 92022)	92022-1827	1
SPACER (Ref # 92026)	92026-1217	1
PIN,8X39 (Ref # 92043)	92043-0017	1
PIN,PLUNGER (Ref # 92043A)	92043-1676	2
SPRING (Ref # 92145)	92145-0453	2
SPRING,RETURN (Ref # 92145A)	92145-0496	1
SPRING,POSITION LEVER RETURN (Ref # 92145B)	92145-1669	1
COLLAR (Ref # 92152)	92152-1414	1
COLLAR (Ref # 92152A)	92152-2120	1
BOLT,TORX (Ref # 92154)	92154-1621	1
BOLT,FLANGED,6X14 (Ref # 92154A)	92154-2964	1
BOLT,FLANGED,6X25 (Ref # 92154B)	92154-2967	1
BOLT-STUD,6X12 (Ref # 172)	172BA0612	1
NUT-HEX,6MM (Ref # 311)	311BA0600	1