

# 2022 NINJA H2® PARTS DIAGRAM

## Handlebar

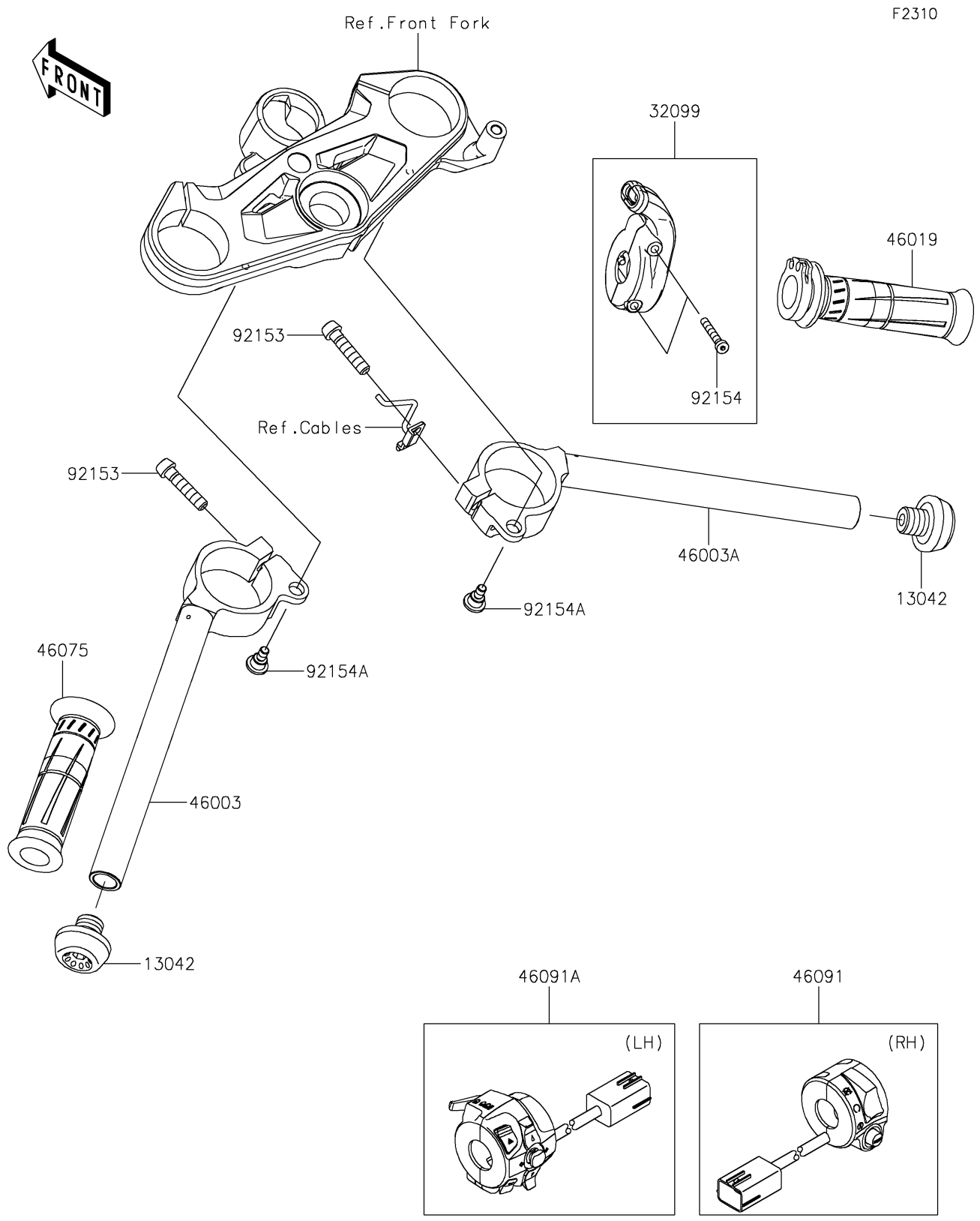

## 2022 NINJA H2® PARTS LIST

### Handlebar

ITEM NAME	PART NUMBER	QUANTITY
WEIGHT,HANDLE,A.BLACK (Ref # 13042)	13042-0049-499	2
CASE,THROTTLE (Ref # 32099)	32099-0766	1
HANDLE,LH (Ref # 46003)	46003-0669	1
HANDLE,RH (Ref # 46003A)	46003-0757	1
GRIP-ASSY,THROTTLE (Ref # 46019)	46019-0020	1
GRIP,LH (Ref # 46075)	46075-0068	1
HOUSING-ASSY-CONTROL,RH (Ref # 46091)	46091-0301	1
HOUSING-ASSY-CONTROL,LH (Ref # 46091A)	46091-0462	1
BOLT,SOCKET,8X35 (Ref # 92153)	92153-0907	2
BOLT,SOCKET,5X35 (Ref # 92154)	92154-1530	2
BOLT,SOCKET,6X16.5 (Ref # 92154A)	92154-1698	2