

2007 Vulcan 2000 Classic LT PARTS DIAGRAM

Valve(s)

E1210

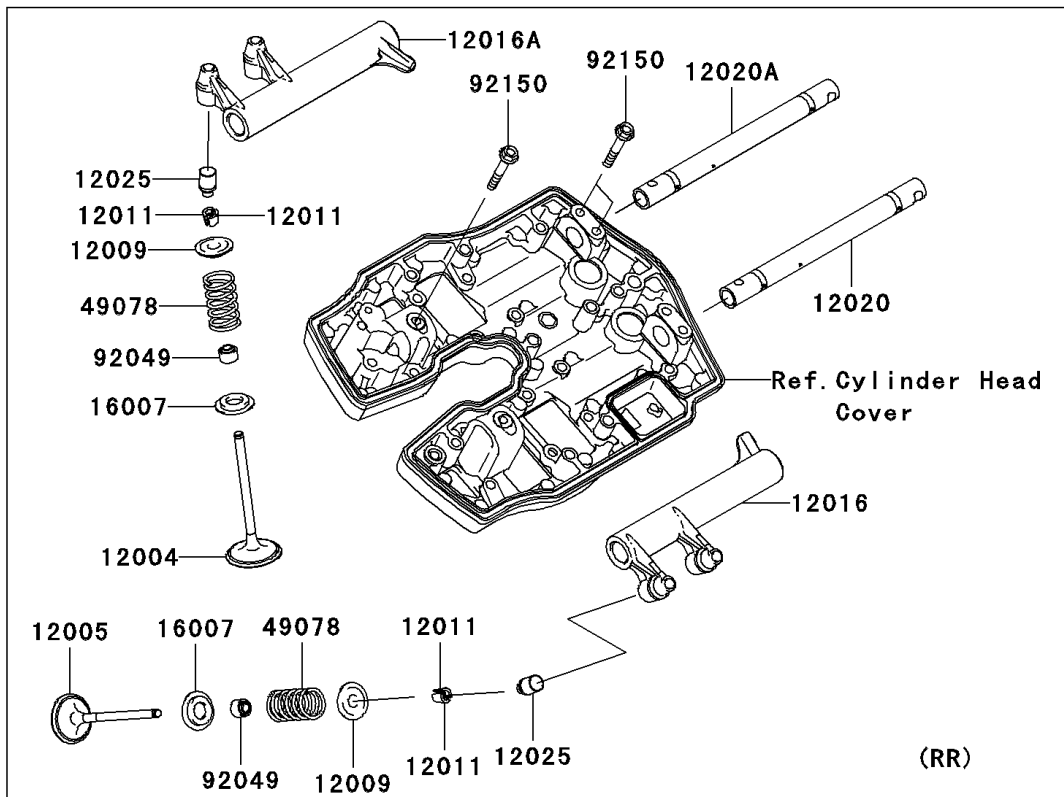
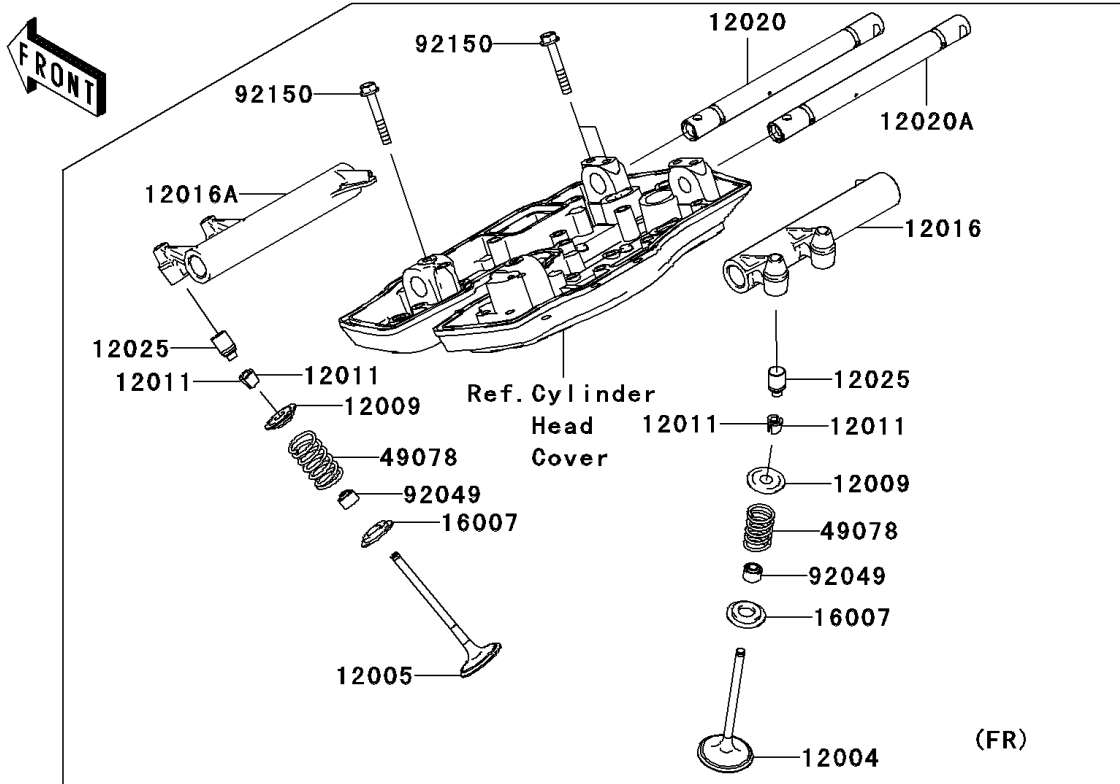

2007 Vulcan 2000 Classic LT PARTS LIST

Valve(s)

ITEM NAME	PART NUMBER	QUANTITY
VALVE-INTAKE (Ref # 12004)	12004-0001	4
VALVE-EXHAUST (Ref # 12005)	12005-0001	4
RETAINER-VALVE SPRING (Ref # 12009)	12009-0002	8
COLLET (Ref # 12011)	12011-0001	16
ARM-ROCKER (Ref # 12016)	12016-0015	2
ARM-ROCKER (Ref # 12016A)	12016-0016	2
SHAFT-ROCKER,EXHAUST (Ref # 12020)	12020-0001	2
SHAFT-ROCKER,INTAKE (Ref # 12020A)	12020-0002	2
ADJUSTER-LASH (Ref # 12025)	12025-1053	8
SEAT-SPRING (Ref # 16007)	16007-0001	8
SPRING-ENGINE VALVE (Ref # 49078)	49078-0001	8
SEAL-OIL,RVC2 6 10.5 9.4 (Ref # 92049)	92049-0009	8
BOLT,6X38 (Ref # 92150)	92150-1301	12