

1996 Vulcan 750 PARTS DIAGRAM

Ignition System

E1830

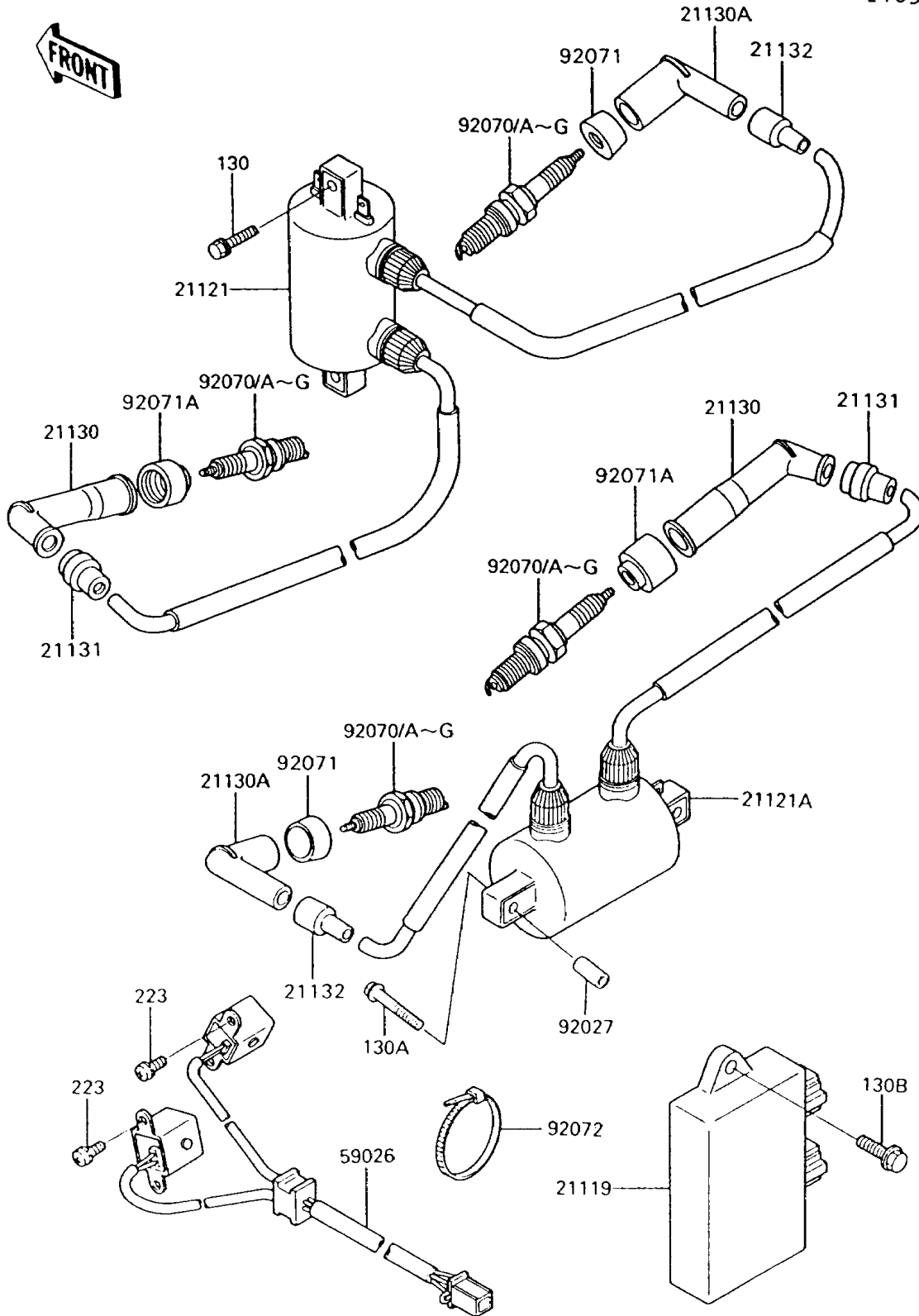

1996 Vulcan 750 PARTS LIST

Ignition System

ITEM NAME	PART NUMBER	QUANTITY
BOLT-FLANGED (Ref # 130)	130D0620	2
BOLT-FLANGED (Ref # 130A)	130D0640	2
BOLT-FLANGED,6X14 (Ref # 130B)	130G0614	2
SCREW-PAN-WS-CROS (Ref # 223)	223B0512	4
IGNITER (Ref # 21119)	21119-1187	1
COIL-IGNITION,FR (Ref # 21121)	21121-1124	1
COIL-IGNITION,RR (Ref # 21121A)	21121-1125	1
CAP-SPARK PLUG (Ref # 21130)	21130-1002	2
CAP-SPARK PLUG (Ref # 21130A)	21130-1003	2
GROMMET,HIGH TENSION (Ref # 21131)	21131-005	2
GROMMET,HIGH TENSION (Ref # 21132)	21132-005	2
COIL-PULSING (Ref # 59026)	59026-1062	1
COLLAR,6.8X10X20 (Ref # 92027)	92027-1856	2
PLUG-SPARK,DP8EA-9(NGK) (Ref # 92070A)	92070-1066	4
PLUG-SPARK,X24EP-U9(ND) (Ref # 92070C)		4
PLUG-SPARK,X22EP-U9(ND) (Ref # 92070D)		4
PLUG-SPARK,DP7EA9(NGK) (Ref # 92070F)	92070-1124	4
GROMMET,SPARK PLUG CAP (Ref # 92071)	92071-1015	2
GROMMET,PLUG CAP (Ref # 92071A)	92071-1124	2
BAND,LEAD WIRE (Ref # 92072)	92072-1181	1