

1996 Vulcan 750 PARTS DIAGRAM

Brake Pedal/Torque Link

F2260

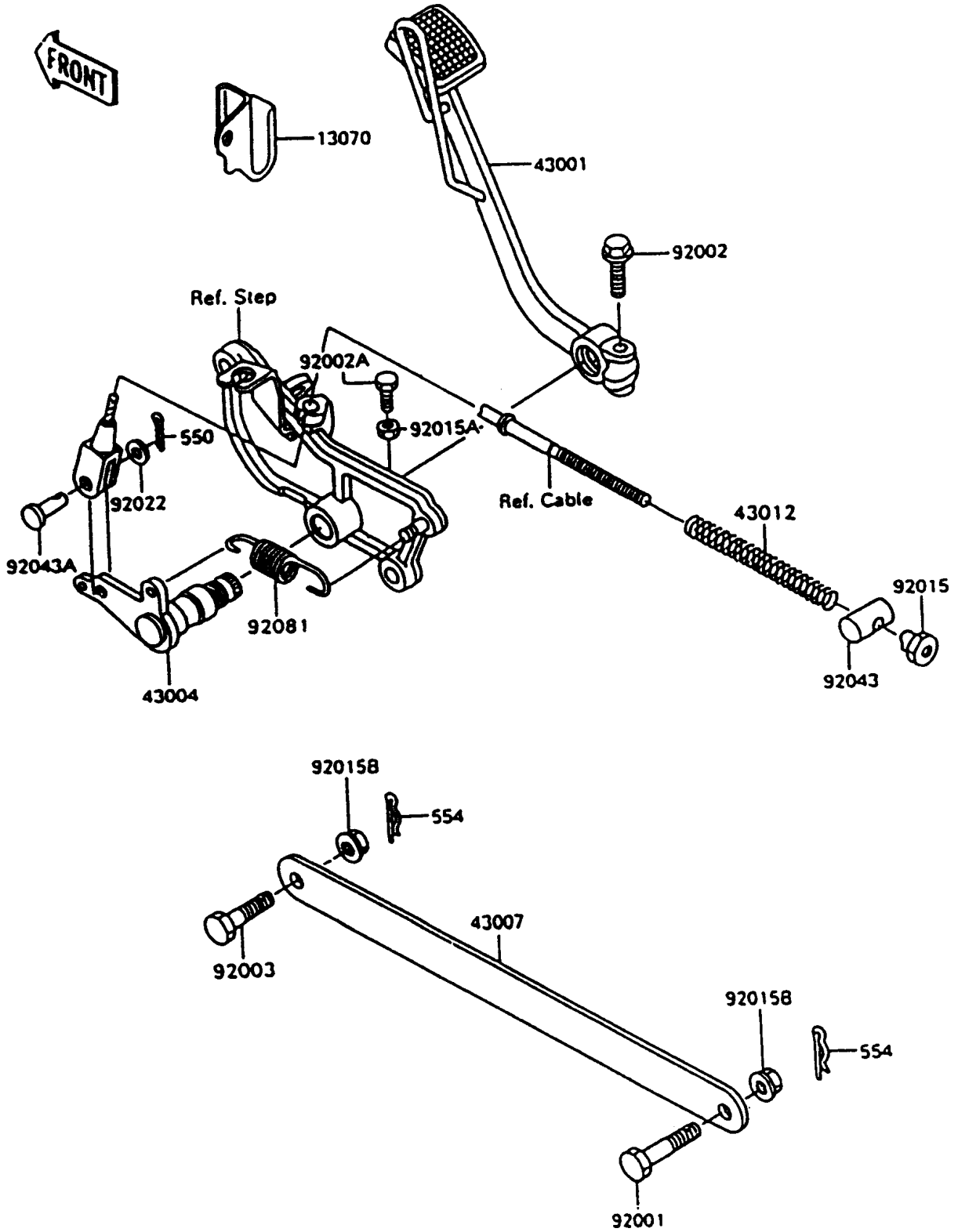

1996 Vulcan 750 PARTS LIST

Brake Pedal/Torque Link

| ITEM NAME | PART NUMBER | QUANTITY |
|----------------------------------|-------------|----------|
| PIN-COTTER,2.0X15 (Ref # 550) | 550D2015 | 1 |
| PIN-SNAP,8MM (Ref # 554) | 554A0800 | 2 |
| GUIDE,CABLE (Ref # 13070) | 13070-1134 | 1 |
| LEVER-BRAKE,PEDAL (Ref # 43001) | 43001-1178 | 1 |
| SHAFT-BRAKE (Ref # 43004) | 43004-1109 | 1 |
| ROD-TORQUE (Ref # 43007) | 43007-1132 | 1 |
| SPRING,BRAKE ROD (Ref # 43012) | 43012-001 | 1 |
| BOLT,10X37 (Ref # 92001) | 92001-1519 | 1 |
| BOLT,FLANGED,8X25 (Ref # 92002) | 92002-1201 | 1 |
| BOLT,6X20 (Ref # 92002A) | 92002-1373 | 1 |
| BOLT,10X29 (Ref # 92003) | 92003-096 | 1 |
| NUT,BRAKE ROD (Ref # 92015) | 92015-042 | 1 |
| NUT,6MM (Ref # 92015A) | 92015-1391 | 1 |
| NUT,FLANGED,10MM (Ref # 92015B) | 92015-1428 | 2 |
| WASHER,8.5X16X1.2 (Ref # 92022) | 92022-1582 | 1 |
| PIN,BRAKE ROD (Ref # 92043) | 92043-065 | 1 |
| PIN,8X16 (Ref # 92043A) | 92043-1013 | 1 |
| SPRING,BRAKE PEDAL (Ref # 92081) | 92081-1845 | 1 |