

1991 Vulcan 750 PARTS DIAGRAM

Cylinder Head

E1111

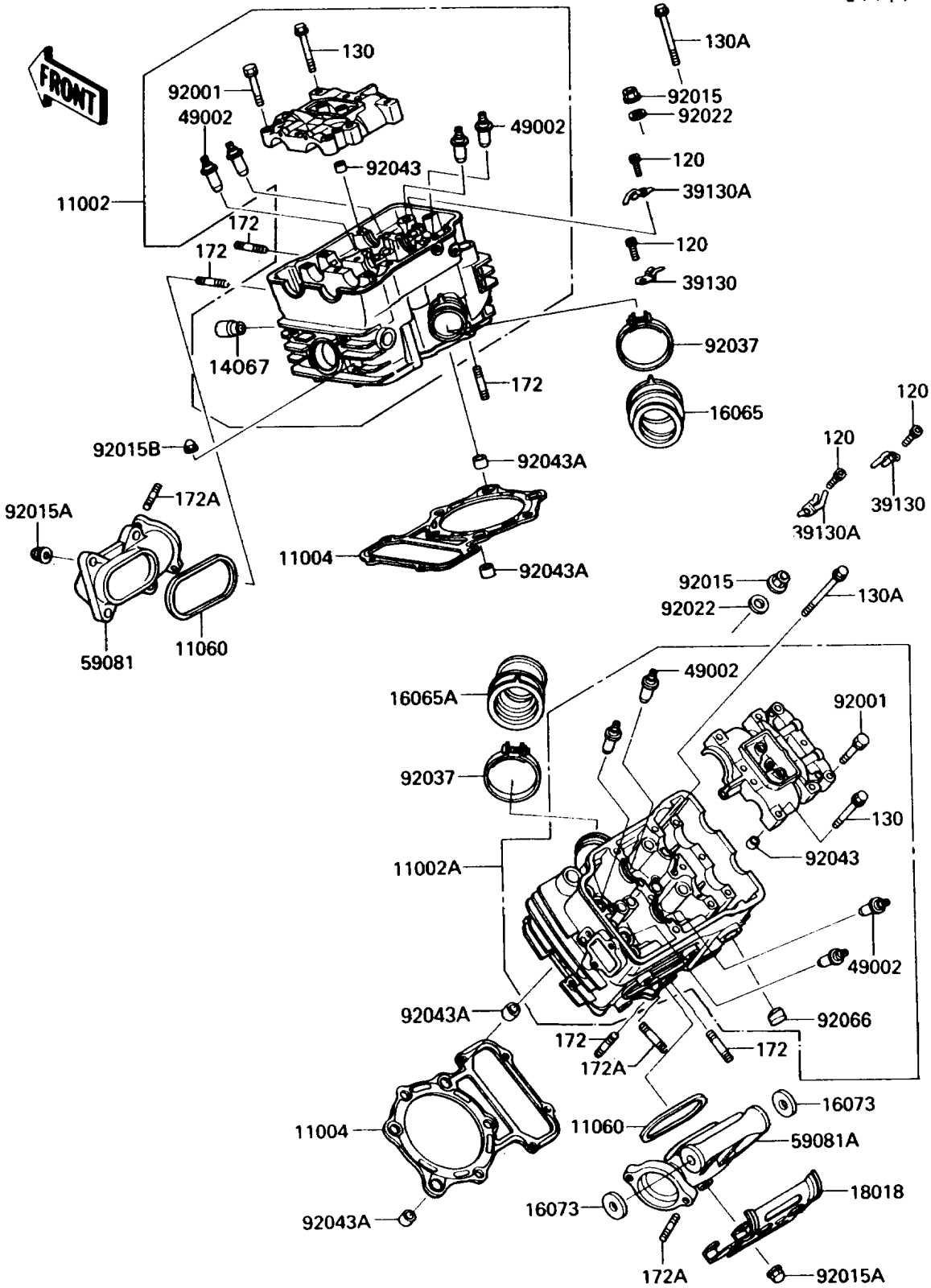

1991 Vulcan 750 PARTS LIST

Cylinder Head

ITEM NAME	PART NUMBER	QUANTITY
BOLT-SOCKET,6X14 (Ref # 120)	120P0614	4
BOLT-FLANGED (Ref # 130)	130P0645	10
BOLT-FLANGED (Ref # 130A)	130P0675	4
BOLT-STUD,8X25 (Ref # 172)	172G0825	10
BOLT-STUD,8X30 (Ref # 172A)	172G0830	6
HEAD-ASSY-CYLINDER,FR (Ref # 11002)	11002-1214	1
HEAD-ASSY-CYLINDER,RR (Ref # 11002A)	11002-1215	1
GASKET-HEAD (Ref # 11004)	11004-1135	2
GASKET,EXHAUST MANIFOLD (Ref # 11060)	11060-1082	2
FITTING,BREATHER (Ref # 14067)	14067-006	1
HOLDER-CARBURETOR,FR (Ref # 16065)	16065-1122	1
HOLDER-CARBURETOR,RR (Ref # 16065A)	16065-1123	1
INSULATOR (Ref # 16073)	16073-1058	2
PLATE-HEAT GUARD (Ref # 18018)	18018-1065	1
SPRING-LEAF,ROCKER ARM (Ref # 39130)	39130-1055	2
SPRING-LEAF,ROCKER ARM (Ref # 39130A)	39130-1056	2
GUIDE-VALVE (Ref # 49002)	49002-1052	8
MANIFOLD-EXHAUST,FR (Ref # 59081)	59081-1125	1
MANIFOLD-EXHAUST,RR (Ref # 59081A)	59081-1141	1
BOLT,FLANGED,6X38 (Ref # 92001)	92001-1105	10
NUT,FLANGED CAP,10MM (Ref # 92015)	92015-076	8
NUT,CAP,8MM,BLACK (Ref # 92015A)	92015-1174	8
NUT,CAP,6MM (Ref # 92015B)	92015-1385	4
WASHER,10.5X20X1.6 (Ref # 92022)	92022-1591	8
CLAMP (Ref # 92037)	92037-1632	2
PIN,6.2X8X14 (Ref # 92043)	92043-1263	4
PIN,11X14X12.3 (Ref # 92043A)	92043-1266	4
PLUG,BREATHER (Ref # 92066)	92066-1035	1