

1990 Vulcan 750 PARTS DIAGRAM

Crankcase

E1411

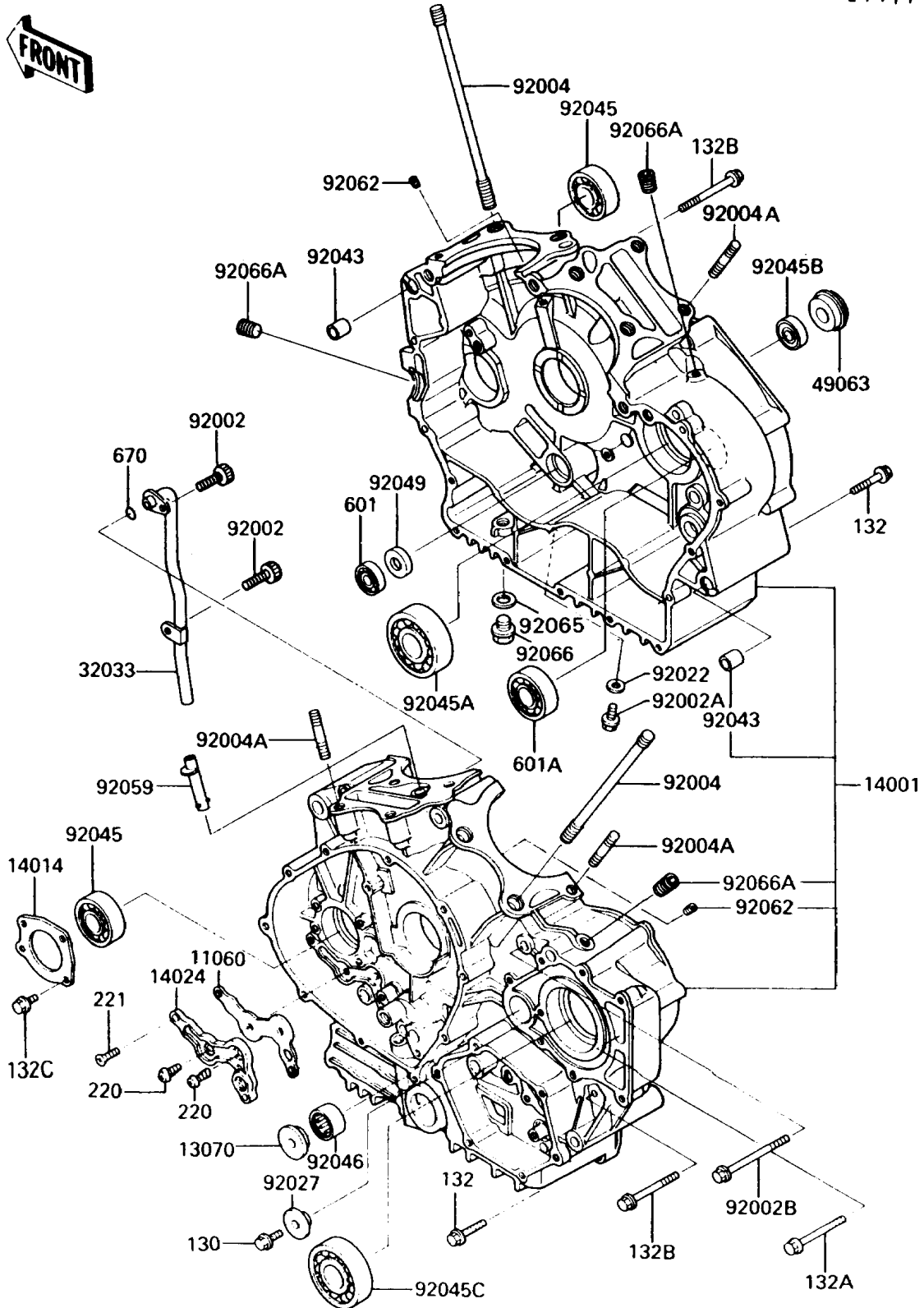

1990 Vulcan 750 PARTS LIST

Crankcase

ITEM NAME	PART NUMBER	QUANTITY
BOLT-FLANGED (Ref # 130)	130P0616	1
BOLT-FLANGED-SMALL (Ref # 132)	132E0630	8
BOLT-FLANGED-SMALL (Ref # 132A)	132E0640	1
BOLT-FLANGED-SMALL (Ref # 132B)	132E0660	3
BOLT-FLANGED-SMALL (Ref # 132C)	132G0616	4
SCREW-PAN-CROS,6X16 (Ref # 220)	220B0616	2
SCREW-CSK-CROS,6X20 (Ref # 221)	221B0620	1
BEARING-BALL (Ref # 601)	601A6001	1
BEARING-BALL (Ref # 601A)	601A6204Z	1
O RING,8MM (Ref # 670)	670B1508	1
GASKET,OIL LINE COVER (Ref # 11060)	11060-1087	1
GUIDE (Ref # 13070)	13070-1127	1
SET-CRANKCASE (Ref # 14001)	14001-5205	1
PLATE-POSITION (Ref # 14014)	14014-1068	1
COVER,OIL LINE (Ref # 14024)	14024-1074	1
PIPE,BREATHER (Ref # 32033)	32033-1649	1
SEAL-MECHANICAL (Ref # 49063)	49063-1052	1
BOLT,SOCKET,6X14 (Ref # 92002)	92002-1592	2
BOLT,6X10 (Ref # 92002A)	92002-1628	1
BOLT,10X80 (Ref # 92002B)	92002-1629	3
STUD,10X163 (Ref # 92004)	92004-1140	8
STUD,8X28.5 (Ref # 92004A)	92004-1142	6
WASHER,6.1X12X1 (Ref # 92022)	92022-077	1
COLLAR (Ref # 92027)	92027-1844	1
PIN,11X14X12.3 (Ref # 92043)	92043-1266	2
BEARING-BALL,TMB204 JR (Ref # 92045)	92045-1041	2
BEARING-BALL,TMB305 (Ref # 92045A)	92045-1137	1
BEARING-BALL,6001LLU (Ref # 92045B)	92045-1151	1
BEARING-BALL,TMB305X3 (Ref # 92045C)	92045-1167	1

1990 Vulcan 750 PARTS LIST

Crankcase

ITEM NAME	PART NUMBER	QUANTITY
BEARING-NEEDLE,HK2016 (Ref # 92046)	92046-1054	1
SEAL-OIL,AC037AE0 (Ref # 92049)	92049-1228	1
TUBE (Ref # 92059)	92059-1620	1
NOZZLE,BLACK (Ref # 92062)	92062-011	4
GASKET,12X22X2,DRAIN PLUG (Ref # 92065)	92065-097	1
PLUG,OIL DRAIN,12X15 (Ref # 92066)	92066-1174	1
PLUG,OIL LINE,1/8X7 (Ref # 92066A)	92066-1227	4