

# 1993 Vulcan 750 PARTS DIAGRAM

Front Bevel Gear

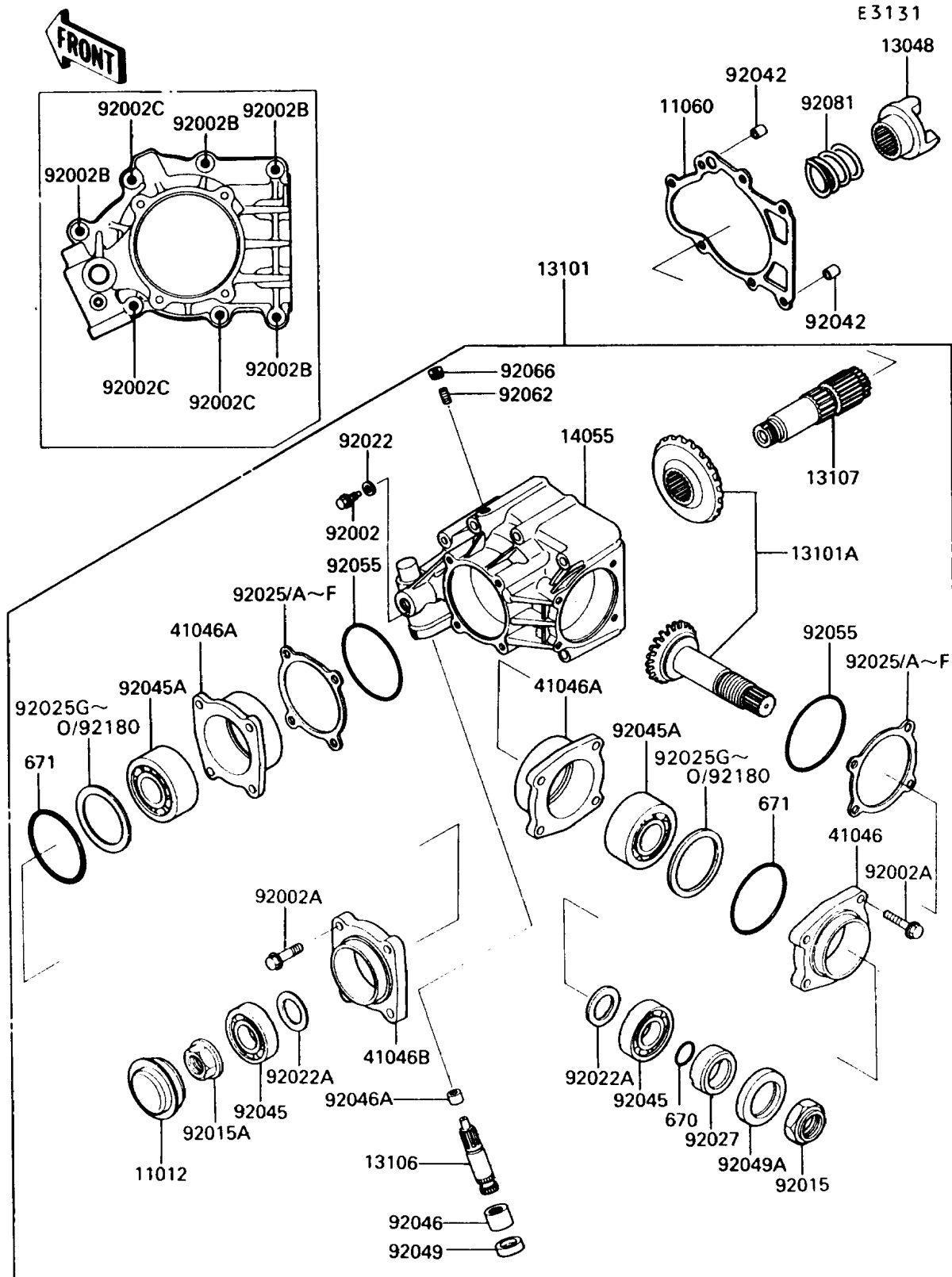

# 1993 Vulcan 750 PARTS LIST

## Front Bevel Gear

ITEM NAME	PART NUMBER	QUANTITY
CAP,FRONT BEVEL (Ref # 11012)	11012-1672	1
GASKET,GEAR CASE (Ref # 11060)	11060-1086	1
CAM-DAMPER (Ref # 13048)	13048-1058	1
GEAR-ASSY,BEVEL,FR (Ref # 13101)	13101-1094	1
GEAR-ASSY,BEVEL,FR (Ref # 13101A)	13101-5048	1
SHAFT-CLUTCH RELEASE (Ref # 13106)	13106-1068	1
SHAFT,BEVEL GEAR,FR (Ref # 13107)	13107-1166	1
CASE-GEAR,BEVEL,FR (Ref # 14055)	14055-1068	1
HOUSING-BEARING,BEVEL,FR (Ref # 41046)	41046-1072	1
HOUSING-BEARING,BEVEL,FR (Ref # 41046A)	41046-1073	2
HOUSING-BEARING,BEVEL,FR (Ref # 41046B)	41046-1090	1
BOLT (Ref # 92002)	92002-1357	1
BOLT,6X32 (Ref # 92002A)	92002-1623	8
BOLT,6X85 (Ref # 92002B)	92002-1624	4
BOLT (Ref # 92002C)	92002-1625	3
NUT,25MM (Ref # 92015)	92015-1480	1
NUT (Ref # 92015A)	92015-1543	1
WASHER,6.1X12X1 (Ref # 92022)	92022-077	1
WASHER (Ref # 92022A)	92022-1719	2
SHIM,T=0.10 (Ref # 92025)	92025-1258	AR
SHIM,T=0.15 (Ref # 92025A)	92025-1259	AR
SHIM,T=0.20 (Ref # 92025B)	92025-1260	AR
SHIM,T=0.30 (Ref # 92025C)	92025-1261	AR
SHIM,T=0.60 (Ref # 92025D)	92025-1262	AR
SHIM,T=0,90 (Ref # 92025E)	92025-1263	AR
SHIM,T=1.20 (Ref # 92025F)	92025-1264	AR
SHIM,52.5X61.5X0.15 (Ref # 92025G)	92025-1669	AR
SHIM,52.5X61.5X0.18 (Ref # 92025H)	92025-1670	AR
SHIM,52.5X61.5X0.8 (Ref # 92025I)	92025-1671	AR

# 1993 Vulcan 750 PARTS LIST

## Front Bevel Gear

ITEM NAME	PART NUMBER	QUANTITY
SHIM,52.5X61.5X0.9 (Ref # 92025J)	92025-1672	AR
SHIM,52.5X61.5X1.0 (Ref # 92025K)	92025-1673	AR
SHIM,52.5X61.5X1.1 (Ref # 92025L)	92025-1674	AR
SHIM,52.5X61.5X1.2 (Ref # 92025M)	92025-1675	AR
SHIM,52.5X61.5X1.3 (Ref # 92025N)	92025-1676	AR
SHIM,52.5X61.5X1.4 (Ref # 92025O)	92025-1677	AR
COLLAR (Ref # 92027)	92027-1843	1
PIN,DOWEL,6.3X8X14 (Ref # 92042)	92042-007	2
BEARING-BALL,6205 (Ref # 92045)	92045-1115	2
BEARING-BALL,5305SH2CD2 (Ref # 92045A)	92045-1147	2
BEARING-NEEDLE,7E-HK1412 (Ref # 92046)	92046-037	1
O RING,21MM (Ref # 670)	670B2021	1
O RING,65MM (Ref # 671)	671B2565	2
BEARING-NEEDLE,HK0709 (Ref # 92046A)	92046-1142	1
SEAL-OIL,TC14244.8 (Ref # 92049)	92049-1037	1
SEAL-OIL,TC35527 (Ref # 92049A)	92049-1038	1
RING-O (Ref # 92055)	92055-1306	2
NOZZLE,BLACK (Ref # 92062)	92062-011	1
PLUG,OIL LINE,1/8X7 (Ref # 92066)	92066-1227	1
SPRING (Ref # 92081)	92081-1552	1
SHIM,52.5X61.5X0.10 (Ref # 92180)	92180-1115	AR