

1996 Vulcan 800 PARTS DIAGRAM

Crankcase

E1411

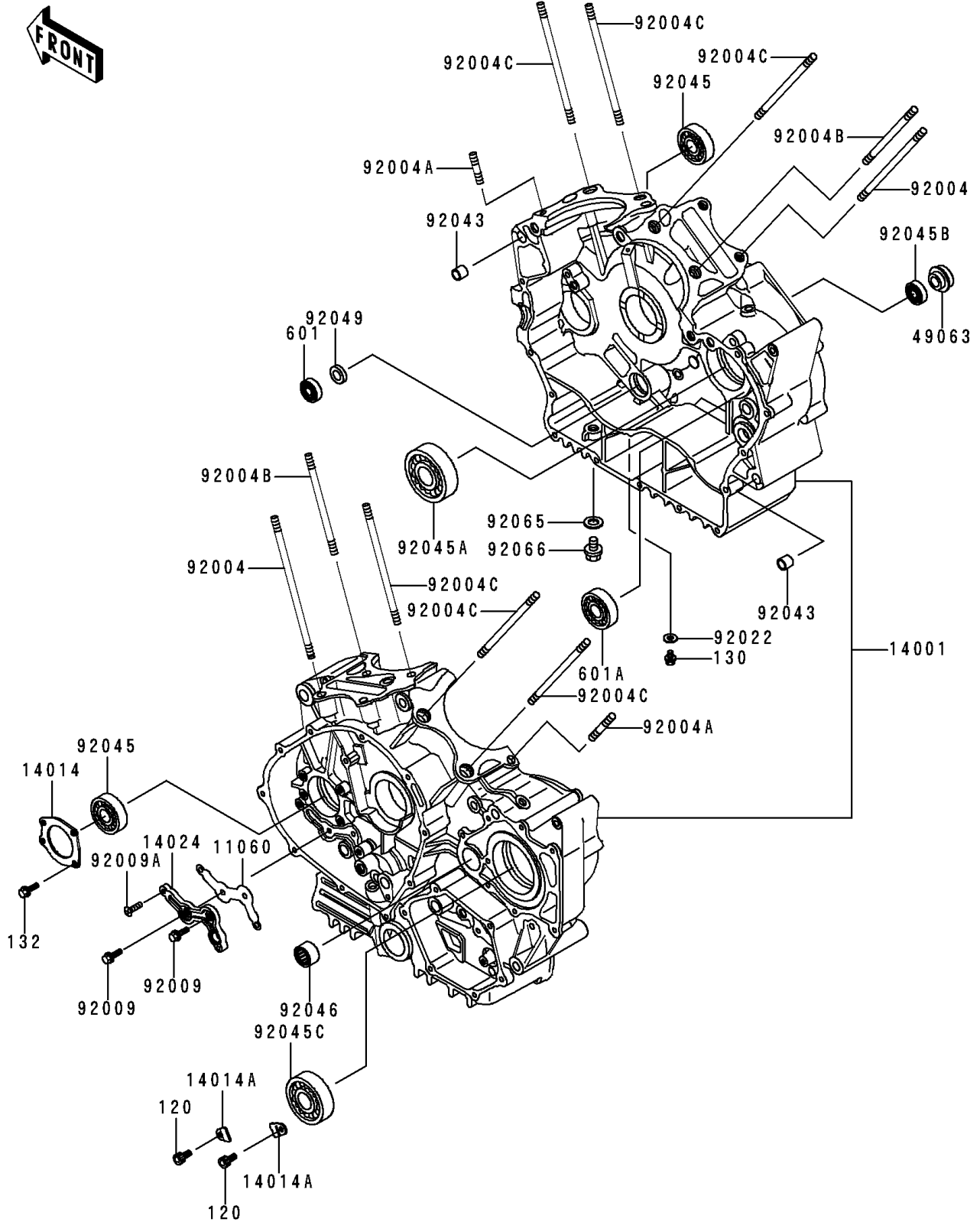

1996 Vulcan 800 PARTS LIST

Crankcase

ITEM NAME	PART NUMBER	QUANTITY
BOLT-SOCKET (Ref # 120)	120S0612	2
BOLT-FLANGED (Ref # 130)	130J0610	1
BOLT-FLANGED-SMALL (Ref # 132)	132G0616	4
BEARING-BALL (Ref # 601)	601A6001	1
BEARING-BALL (Ref # 601A)	601A6204Z	1
GASKET,OIL LINE COVER (Ref # 11060)	11060-1087	1
SET-CRANKCASE (Ref # 14001)	14001-5342	1
PLATE-POSITION (Ref # 14014)	14014-1068	1
PLATE-POSITION (Ref # 14014A)	14014-1121	2
COVER,OIL LINE (Ref # 14024)	14024-1074	1
SEAL-MECHANICAL (Ref # 49063)	49063-1052	1
STUD,8M/M (Ref # 92004)	92004-1035	4
STUD,8X28.5 (Ref # 92004A)	92004-1142	2
STUD,10X148 (Ref # 92004B)	92004-1220	2
STUD,10X160 (Ref # 92004C)	92004-1221	6
SCREW (Ref # 92009)	92009-1266	2
SCREW,6X20 (Ref # 92009A)	92009-1447	1
WASHER,6.1X12X1 (Ref # 92022)	92022-077	1
PIN,11X14X12.3 (Ref # 92043)	92043-1266	2
BEARING-BALL,TMB204 JR (Ref # 92045)	92045-1041	2
BEARING-BALL,TMB305 (Ref # 92045A)	92045-1137	1
BEARING-BALL,6001LLU (Ref # 92045B)	92045-1151	1
BEARING-BALL,TMB305X3 (Ref # 92045C)	92045-1167	1
BEARING-NEEDLE (Ref # 92046)	92046-1239	1
SEAL-OIL,AC037AE0 (Ref # 92049)	92049-1228	1
GASKET,12X22X2,DRAIN PLUG (Ref # 92065)	92065-097	1
PLUG,OIL DRAIN,12X15 (Ref # 92066)	92066-1174	1