

1996 Vulcan 800 PARTS DIAGRAM

Carburetor

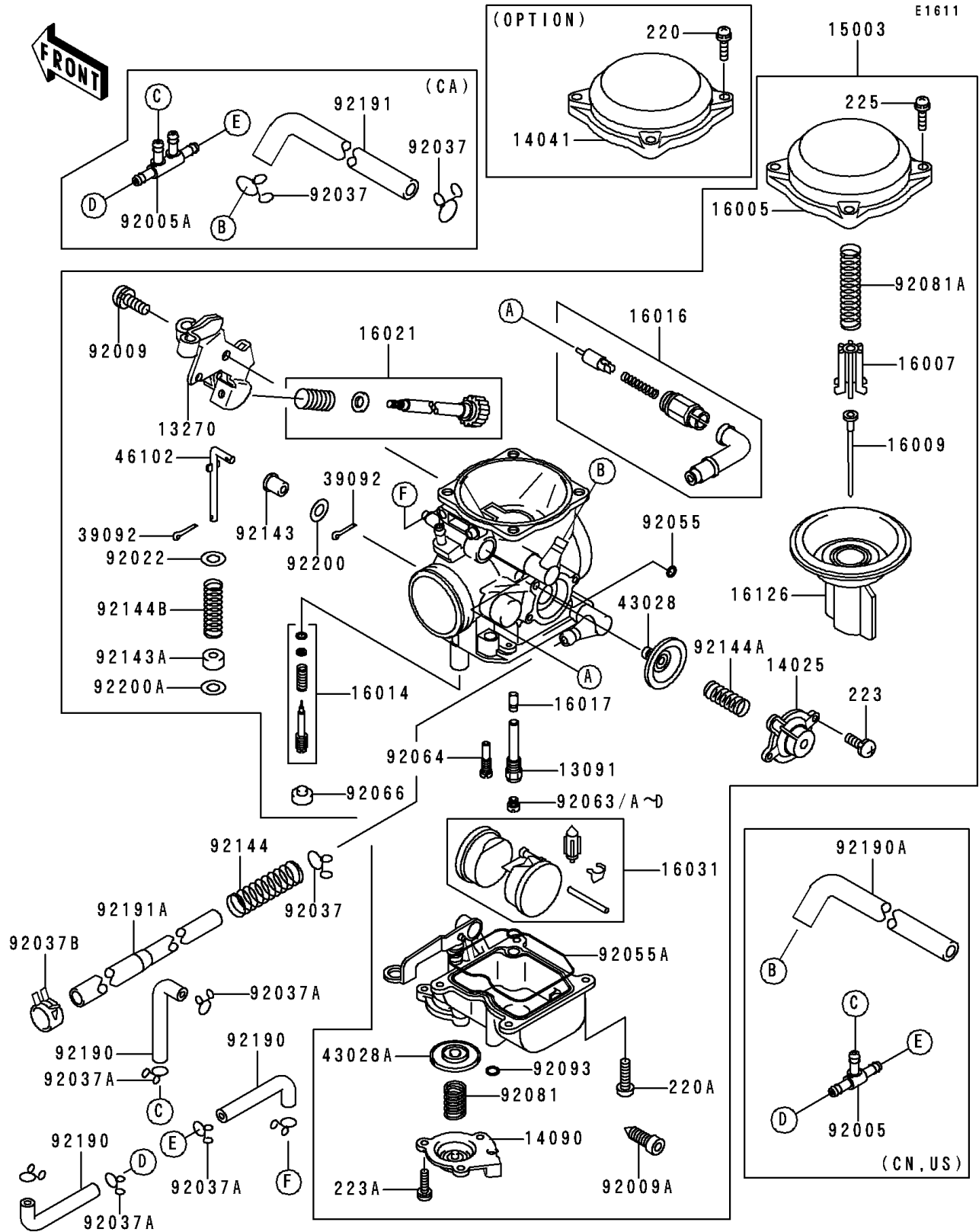

1996 Vulcan 800 PARTS LIST

Carburetor

| ITEM NAME | PART NUMBER | QUANTITY |
|--|-------------|----------|
| HOLDER (Ref # 13091) | 13091-1930 | 1 |
| PLATE (Ref # 13270) | 13270-1513 | 1 |
| COVER,AIR CUT VALVE (Ref # 14025) | 14025-1903 | 1 |
| TOP-CHAMBER,MIXING,OUTSIDE (Ref # 14041) | 14041-1076 | 1 |
| COVER,ACCELERATOR (Ref # 14090) | 14090-1635 | 1 |
| CARBURETOR-ASSY (Ref # 15003) | 15003-1200 | 1 |
| TOP-CHAMBER,MIXING,27/60 (Ref # 16005) | 16005-1057 | 1 |
| SEAT-SPRING,VALVE (Ref # 16007) | 16007-1117 | 1 |
| NEEDLE-JET (Ref # 16009) | 16009-1861 | 1 |
| SCREW-PILOT AIR (Ref # 16014) | 16014-1081 | 1 |
| PLUNGER,STARTER (Ref # 16016) | 16016-1100 | 1 |
| JET-NEEDLE (Ref # 16017) | 16017-1377 | 1 |
| SCREW-THROTTLE STOP (Ref # 16021) | 16021-1207 | 1 |
| FLOAT (Ref # 16031) | 16031-1089 | 1 |
| VALVE,VACUUM (Ref # 16126) | 16126-1170 | 1 |
| PIN-HAIR (Ref # 39092) | 39092-1058 | 2 |
| DIAPHRAGM,AIR CUT VALVE (Ref # 43028) | 43028-1053 | 1 |
| DIAPHRAGM (Ref # 43028A) | 43028-1077 | 1 |
| ROD (Ref # 46102) | 46102-1385 | 1 |
| SCREW,5X10 (Ref # 92009) | 92009-1365 | 1 |
| SCREW,DRAIN,M6X0.75 (Ref # 92009A) | 92009-1551 | 1 |
| WASHER,PLAIN,STOP SPRING (Ref # 92022) | 92022-1480 | 1 |
| CLAMP (Ref # 92037A) | 92037-1610 | 6 |
| CLAMP (Ref # 92037B) | 92037-2082 | 1 |
| RING-O (Ref # 92055) | 92055-1245 | 1 |
| RING-O,FLOAT CHAMBER (Ref # 92055A) | 92055-1518 | 1 |
| JET-MAIN,#140 (Ref # 92063) | 92063-1013 | 1 |
| JET-MAIN,#135 (Ref # 92063A) | 92063-1014 | 1 |
| SCREW-PAN-CROS (Ref # 220) | 220B0408 | 4 |

1996 Vulcan 800 PARTS LIST

Carburetor

| ITEM NAME | PART NUMBER | QUANTITY |
|--|-------------|----------|
| SCREW-PAN-CROS (Ref # 220A) | 220D0414 | 4 |
| SCREW-PAN-WS-CROS (Ref # 223) | 223C0408 | 2 |
| SCREW-PAN-WS-CROS (Ref # 223A) | 223D0410 | 3 |
| SCREW-PAN-WSP-CROS (Ref # 225) | 225C0418 | 4 |
| JET-MAIN,#138 (Ref # 92063B) | 92063-1015 | 1 |
| JET-MAIN,#130 (Ref # 92063C) | 92063-1075 | 1 |
| JET-MAIN,#132 (Ref # 92063D) | 92063-1076 | 1 |
| JET-PILOT (Ref # 92064) | 92064-1174 | 1 |
| PLUG,PILOT AIR SCREW,6.9X2 (Ref # 92066) | 92066-1051 | 1 |
| SPRING,DIAPHRAGM (Ref # 92081) | 92081-1092 | 1 |
| SPRING,VACUUM VALVE (Ref # 92081A) | 92081-1826 | 1 |
| SEAL,"U"RING (Ref # 92093) | 92093-1046 | 1 |
| COLLAR (Ref # 92143) | 92143-1790 | 1 |
| COLLAR (Ref # 92143A) | 92143-1791 | 1 |
| SPRING,FUEL TUBE (Ref # 92144) | 92144-1874 | 1 |
| SPRING (Ref # 92144A) | 92144-1885 | 1 |
| SPRING (Ref # 92144B) | 92144-1886 | 1 |
| TUBE,4X9X80 (Ref # 92190) | 92190-1610 | 3 |
| TUBE (Ref # 92191A) | 92191-1041 | 1 |
| WASHER (Ref # 92200) | 92200-1274 | 1 |
| WASHER (Ref # 92200A) | 92200-1275 | 1 |
| FITTING,TUBE,T-TYPE (Ref # 92005) | 92005-1017 | 1 |
| FITTING (Ref # 92005A) | 92005-1307 | 1 |
| CLAMP,HOSE (Ref # 92037) | 92037-1104 | 1 |
| CLAMP,HOSE (Ref # 92037) | 92037-1104 | 3 |
| TUBE,CANISTER-AIR FILTER (Ref # 92190A) | 92190-1619 | 1 |
| TUBE,7X12X480,YELLOW (Ref # 92191) | 92191-1008 | 1 |