

# 1999 Vulcan 800 PARTS DIAGRAM

Swingarm

F2141

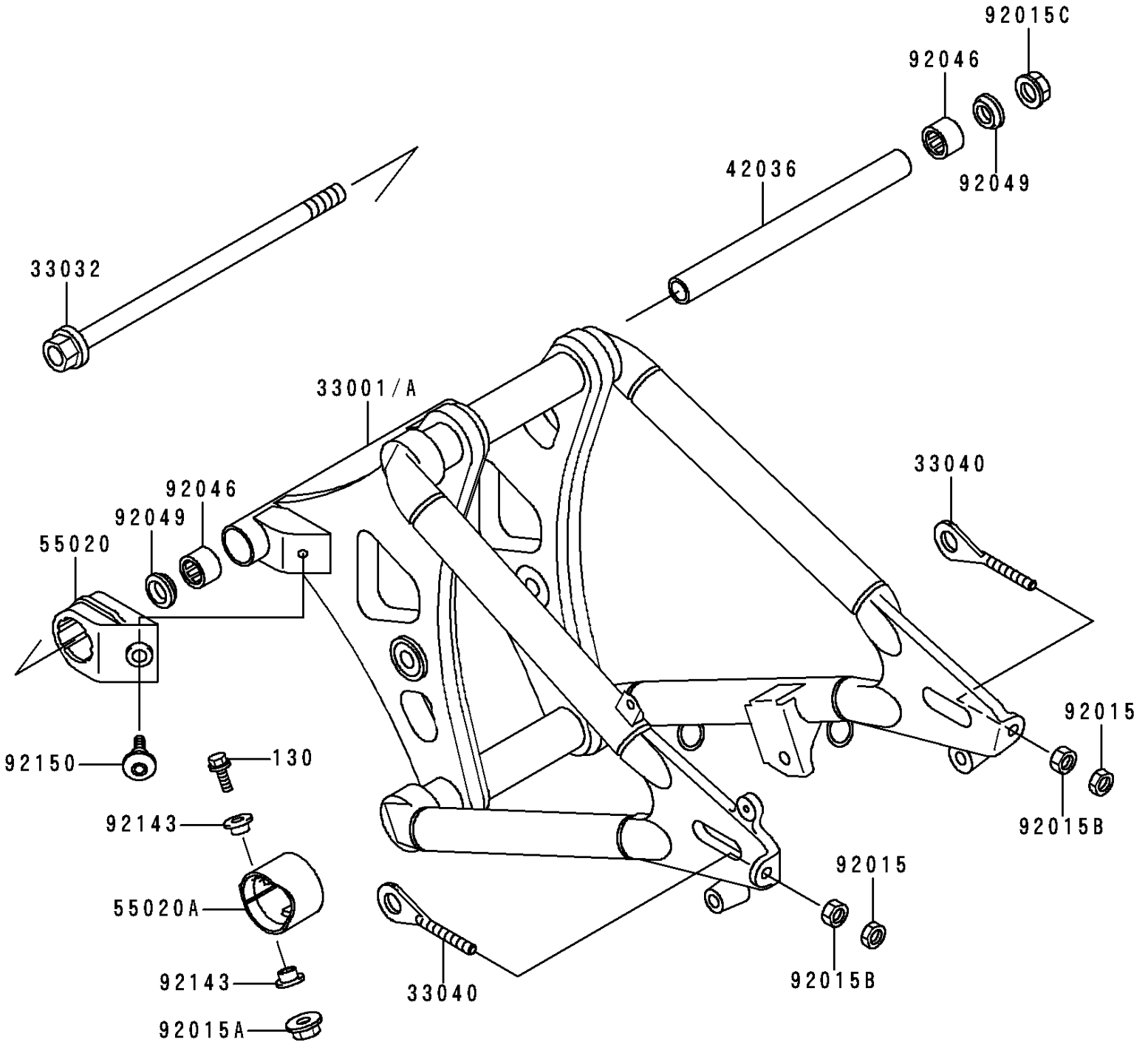

# 1999 Vulcan 800 PARTS LIST

## Swingarm

ITEM NAME	PART NUMBER	QUANTITY
BOLT-FLANGED,6X25 (Ref # 130)	130J0625	1
ARM-COMP-SWING (Ref # 33001A)	33001-1509	1
SHAFT-SWING ARM (Ref # 33032)	33032-1177	1
ADJUSTER-CHAIN (Ref # 33040)	33040-1146	2
SLEEVE,SWING ARM,L=243 (Ref # 42036)	42036-1324	1
GUARD,CHAIN PIVOT (Ref # 55020)	55020-1530	1
GUARD,CHAIN CLOSS (Ref # 55020A)	55020-1531	1
NUT,8MM (Ref # 92015)	92015-1364	2
NUT,LOCK,FLANGED,6MM (Ref # 92015A)	92015-1603	1
NUT,8MM (Ref # 92015B)	92015-1658	2
NUT,FLANGED,16MM (Ref # 92015C)	92015-1946	1
BEARING-NEEDLE,TA2230Z (Ref # 92046)	92046-1174	2
SEAL-OIL,MHA22X29X5.7F (Ref # 92049)	92049-1289	2
COLLAR,L=6.6 (Ref # 92143)	92143-1088	2
BOLT,SOCKET,6MM (Ref # 92150)	92150-1154	1