

1996 Vulcan 800 PARTS DIAGRAM

Suspension/Shock Absorber

F2151

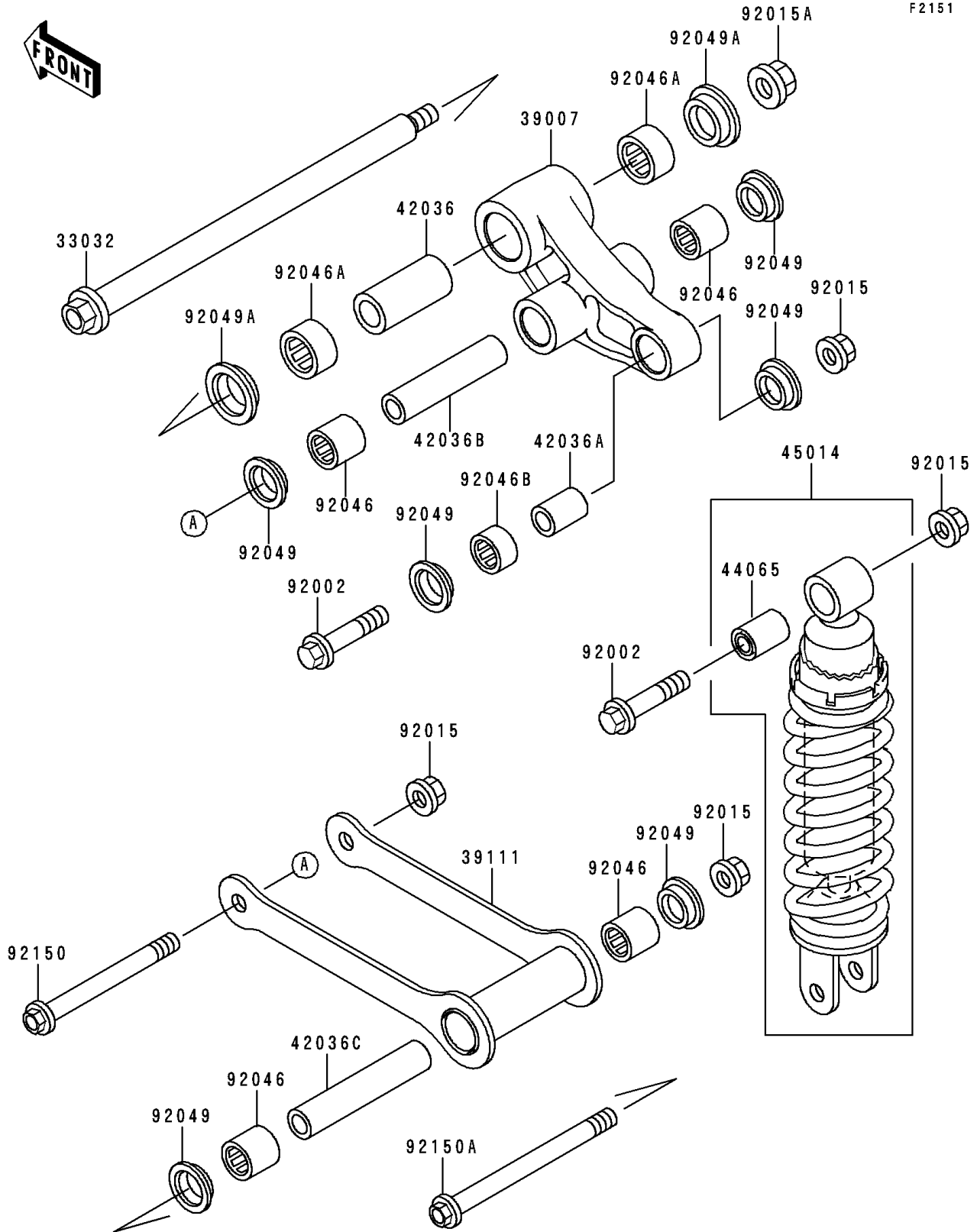

1996 Vulcan 800 PARTS LIST

Suspension/Shock Absorber

ITEM NAME	PART NUMBER	QUANTITY
SHAFT-SWING ARM (Ref # 33032)	33032-1176	1
ARM-SUSP,UNI TRAK (Ref # 39007)	39007-1233	1
ROD-TIE,SUSPENSION (Ref # 39111)	39111-1141	1
SLEEVE,20X28X60 (Ref # 42036)	42036-1207	1
SLEEVE,12.1X20X30 (Ref # 42036A)	42036-1234	1
SLEEVE,12.1X20X92 (Ref # 42036B)	42036-1322	1
SLEEVE,12.1X20X108 (Ref # 42036C)	42036-1323	1
BUSHING,SHOCKABSORBER (Ref # 44065)	44065-1017	1
SHOCKABSORBER (Ref # 45014)	45014-1598	1
BOLT,12X55 (Ref # 92002)	92002-1130	2
NUT,FLANGED,12MM (Ref # 92015)	92015-1433	4
NUT,FLANGED,16MM (Ref # 92015A)	92015-1946	1
BEARING-NEEDLE,BM202726 (Ref # 92046)	92046-1110	4
BEARING-NEEDLE,BM2817 (Ref # 92046A)	92046-1111	2
BEARING-NEEDLE,BM202715 (Ref # 92046B)	92046-1112	1
SEAL-OIL,ARM,CNT (Ref # 92049)	92049-1109	6
SEAL-OIL (Ref # 92049A)	92049-1181	2
BOLT,FLANGED,12X117 (Ref # 92150)	92150-1895	1
BOLT,FLANGED,12X145 (Ref # 92150A)	92150-1896	1