

1995 Vulcan 800 PARTS DIAGRAM

Front Wheel

F2230

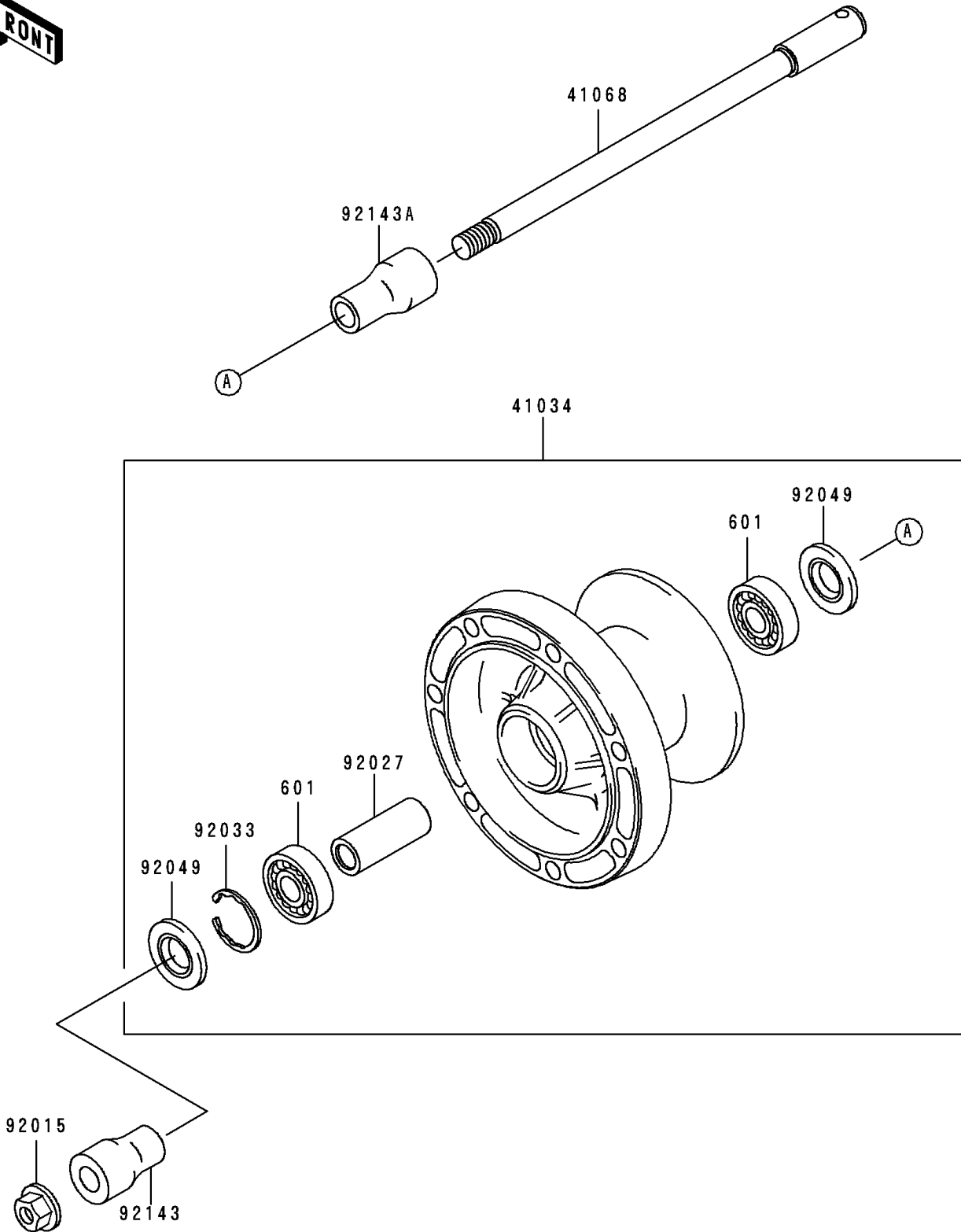

1995 Vulcan 800 PARTS LIST

Front Wheel

ITEM NAME	PART NUMBER	QUANTITY
BEARING-BALL,#6302UG (Ref # 601)	601B6302UG	2
DRUM-ASSY,FRONT BRAKE (Ref # 41034)	41034-1247	1
AXLE,FR (Ref # 41068)	41068-1243	1
NUT,14MM (Ref # 92015)	92015-1407	1
COLLAR,L=70 (Ref # 92027)	92027-1866	1
RING-SNAP,42MM (Ref # 92033)	92033-1041	1
SEAL-OIL,BJN22425 (Ref # 92049)	92049-1058	2
COLLAR,FR AXLE,LH,L=47.5 (Ref # 92143)	92143-1737	1
COLLAR,FR AXLE,RH,L=56.5 (Ref # 92143A)	92143-1738	1