

1998 Vulcan 800 PARTS DIAGRAM

Rear Wheel/Chain

F2240

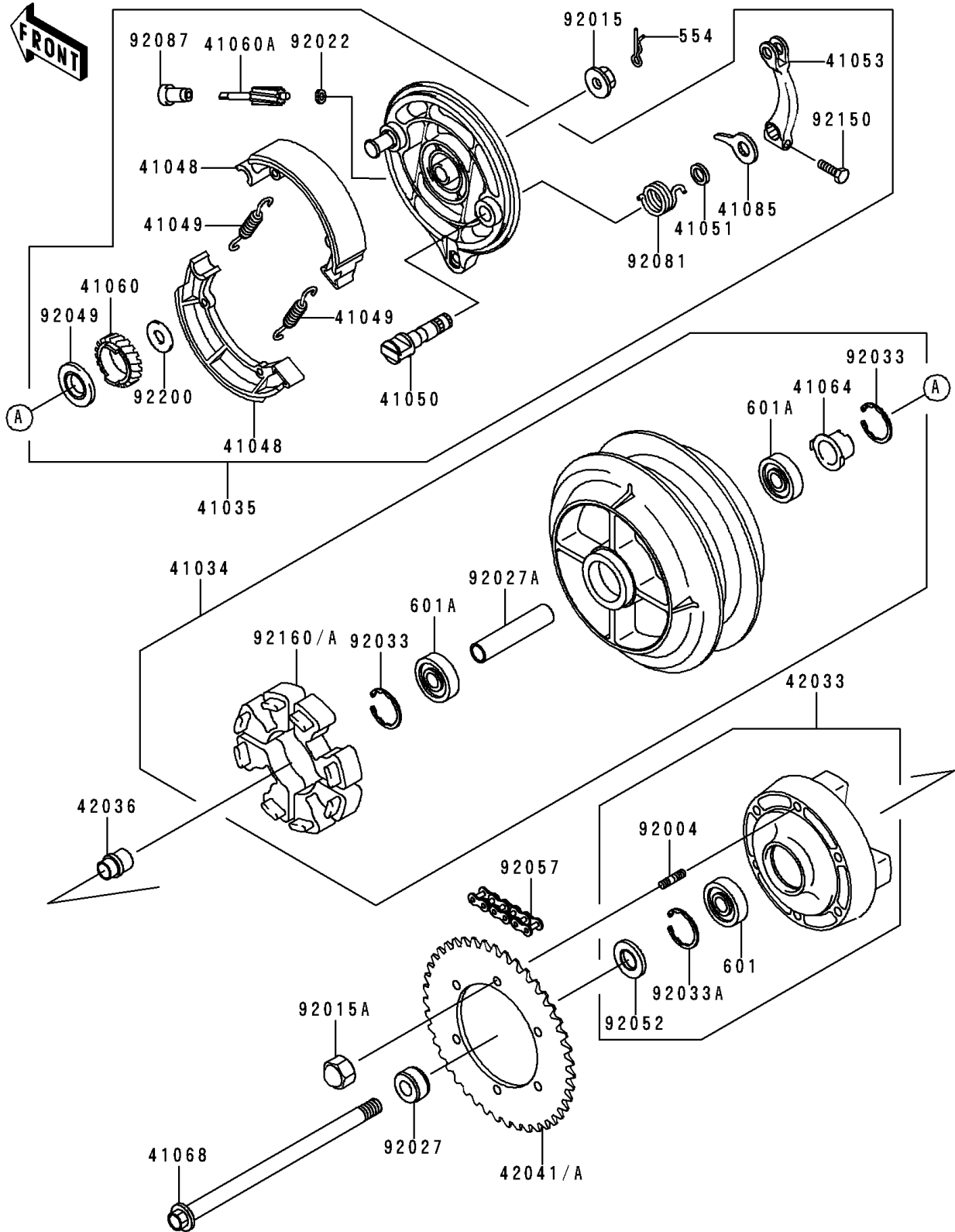

1998 Vulcan 800 PARTS LIST

Rear Wheel/Chain

ITEM NAME	PART NUMBER	QUANTITY
PIN-SNAP,10MM (Ref # 554)	554A1000	1
BEARING-BALL,#6205UG (Ref # 601)	601B6205UG	1
BEARING-BALL,#6303UUC3 (Ref # 601A)	601B6303UU	2
DRUM-ASSY,REAR BRAKE (Ref # 41034)	41034-1248	1
PANEL-ASSY-BRAKE,RR (Ref # 41035)	41035-1482	1
SHOE-BRAKE (Ref # 41048)	41048-1070	2
SPRING,BRAKE SHOE (Ref # 41049)	41049-012	2
CAM-BRAKE (Ref # 41050)	41050-1013	1
SEAL,BRAKE CAM (Ref # 41051)	41051-003	1
LEVER-BRAKE CAM (Ref # 41053)	41053-1063	1
GEAR-METER SCREW,23T (Ref # 41060)	41060-1154	1
GEAR-METER SCREW,8T (Ref # 41060A)	41060-1155	1
RECEIVER-SPEEDOMETER (Ref # 41064)	41064-1057	1
AXLE,RR (Ref # 41068)	41068-1365	1
INDICATOR (Ref # 41085)	41085-1054	1
COUPLING-ASSY,RR HUB (Ref # 42033)	42033-1180	1
SLEEVE,RR HUB,L=33 (Ref # 42036)	42036-1146	1
SPROCKET-HUB,42T (Ref # 42041A)	42041-1473	1
STUD,10X19.5 (Ref # 92004)	92004-1151	6
NUT,FLANGED,16MM (Ref # 92015)	92015-1946	1
NUT,CAP,10MM (Ref # 92015A)	92015-1961	6
WASHER,5X9.5X0.8 (Ref # 92022)	92022-1511	1
COLLAR,REAR AXLE,LH,L=18.5 (Ref # 92027)	92027-1321	1
COLLAR,17.2X25X96 (Ref # 92027A)	92027-1555	1
RING-SNAP,47MM (Ref # 92033)	92033-1042	2
RING-SNAP,52MM (Ref # 92033A)	92033-1043	1
SEAL-OIL,BJN30427-C3 (Ref # 92049)	92049-1057	1
SEAL-OIL,TWC35527 (Ref # 92052)	92052-006	1
CHAIN,DRIVE,EK50MV-OX114L (Ref # 92057)	92057-1369	1

1998 Vulcan 800 PARTS LIST

Rear Wheel/Chain

ITEM NAME	PART NUMBER	QUANTITY
SPRING,BRAKE CAM LEVER RETURN (Ref # 92081)	92081-1816	1
BUSHING-METER GEAR (Ref # 92087)	92087-1060	1
BOLT,8X27 (Ref # 92150)	92150-1797	1
DAMPER,SHOCK,RR HUB (Ref # 92160A)	92160-1697	4
WASHER,24X32X1.5 (Ref # 92200)	92200-1269	1