

1997 Vulcan 800 PARTS DIAGRAM

Chassis Electrical Equipment

F2760

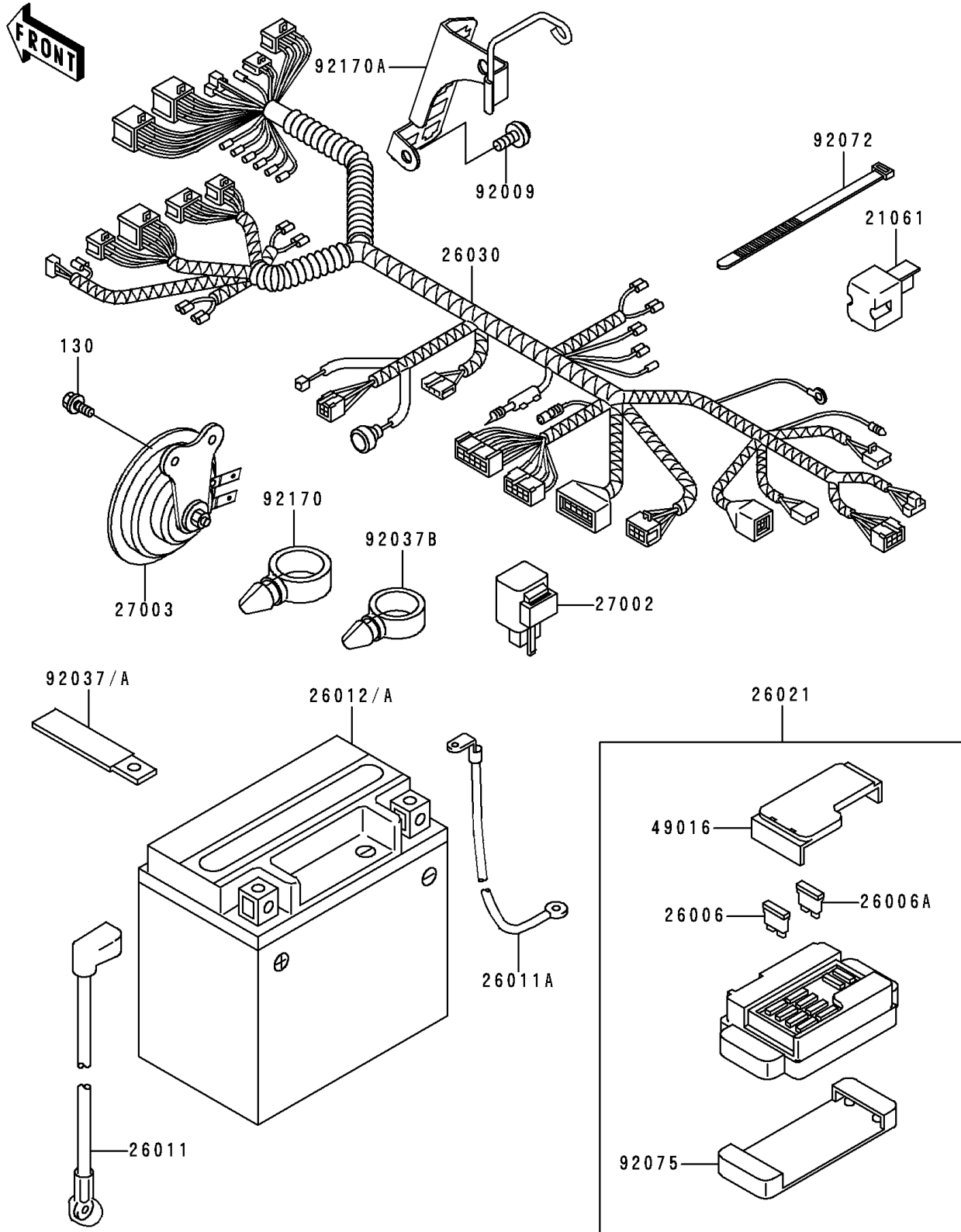

1997 Vulcan 800 PARTS LIST

Chassis Electrical Equipment

ITEM NAME	PART NUMBER	QUANTITY
BOLT-FLANGED (Ref # 130)	130J0612	2
RECTIFIER (Ref # 21061)	21061-1003	2
FUSE,30A-G (Ref # 26006)	26006-1067	1
FUSE,10A-R (Ref # 26006A)	26006-1068	8
WIRE-LEAD,BATTERY(+) (Ref # 26011)	26011-1621	1
WIRE-LEAD,BATTERY(-) (Ref # 26011A)	26011-1633	1
BATTERY,YTX14-BS,12V 12AH (Ref # 26012A)	26012-1334	1
JUNCTION BOX (Ref # 26021)	26021-1089	1
HARNESS,MAIN (Ref # 26030)	26030-1363	1
RELAY-ASSY (Ref # 27002)	27002-1101	1
HORN,350HZ,LH (Ref # 27003)	27003-1239	1
COVER-SEAL,FUSE (Ref # 49016)	49016-1177	1
SCREW,6X14 (Ref # 92009)	92009-1662	2
CLAMP,WIRING HARNESS,L=60 (Ref # 92037)	92037-1069	3
CLAMP,L=45 (Ref # 92037A)	92037-1539	1
CLAMP,HOSE (Ref # 92037B)	92037-1827	2
BAND,L=365 (Ref # 92072)	92072-1197	6
DAMPER,JUNCTION BOX (Ref # 92075)	92075-1688	1
CLAMP (Ref # 92170)	92170-1067	1
CLAMP,HARNESS (Ref # 92170A)	92170-1570	1