

2005 Vulcan 800 PARTS DIAGRAM

Engine Mount

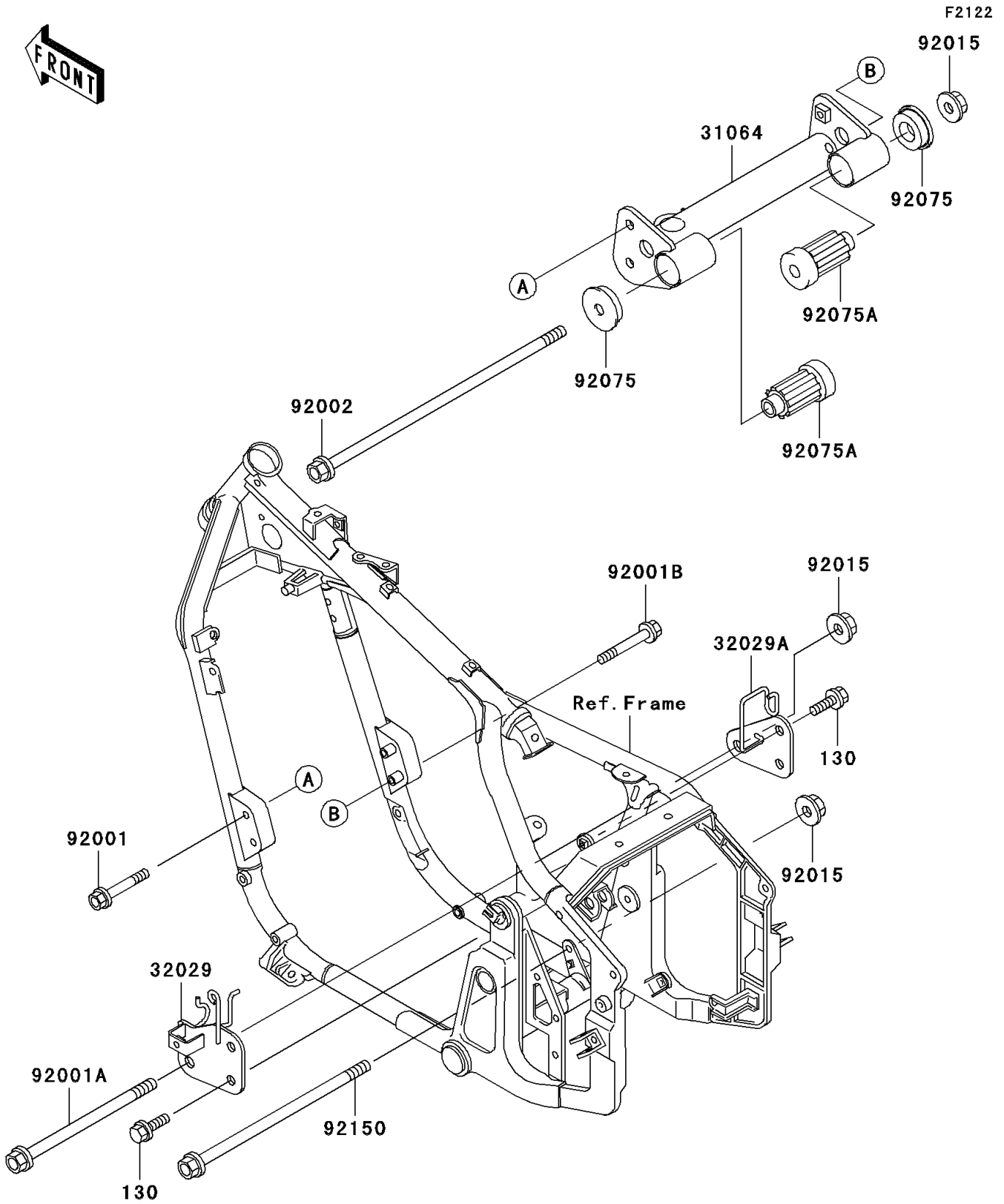

2005 Vulcan 800 PARTS LIST

Engine Mount

ITEM NAME	PART NUMBER	QUANTITY
BOLT-FLANGED,8X16,BLACK (Ref # 130)	130J0816	4
PIPE-COMP,ENGINE MOUNT,FR (Ref # 31064)	31064-1175	1
BRACKET-ENGINE,RR,UPP,LH (Ref # 32029)	32029-1947	1
BRACKET-ENGINE,RR,UPP,RH (Ref # 32029A)	32029-1948	1
BOLT,FLANGED,8X50 (Ref # 92001)	92001-1614	2
BOLT,FLANGED,10X155,BLACK (Ref # 92001A)	92001-1620	1
BOLT,FLANGED,8X55,BLACK (Ref # 92001B)	92001-1641	2
BOLT,FLANGED,10X285 (Ref # 92002)	92002-1206	1
NUT,FLANGED,10MM (Ref # 92015)	92015-1180	3
DAMPER,ENGINE MOUNT (Ref # 92075)	92075-1738	2
DAMPER,ENGINE MOUNT,MAIN (Ref # 92075A)	92075-1739	2
BOLT,FLANGED,10X205 (Ref # 92150)	92150-1899	1