

2005 Vulcan 800 PARTS DIAGRAM

Fenders

F2170

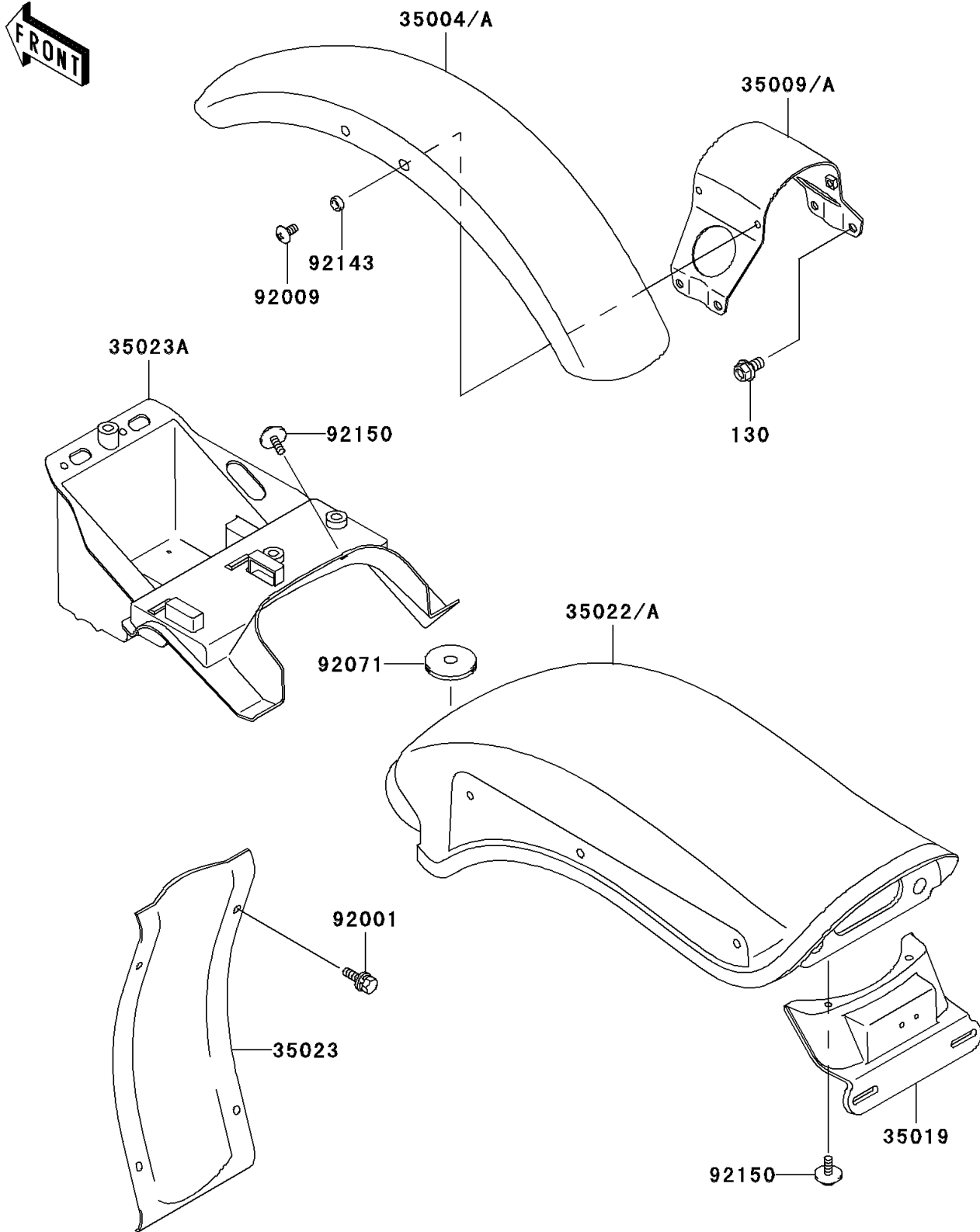

2005 Vulcan 800 PARTS LIST

Fenders

ITEM NAME	PART NUMBER	QUANTITY
BOLT-FLANGED,8X14 (Ref # 130)	130J0814	4
FENDER-FRONT,C.T.BLUE (Ref # 35004A)	35004-1329-386	1
BRACE,FRONT FENDER,C.T.BLUE (Ref # 35009A)	35009-1106-386	1
FLAP,RR (Ref # 35019)	35019-1340	1
FENDER-COMP-REAR,RR,C.T.BLUE (Ref # 35022A)	35022-1318-386	1
FENDER-REAR (Ref # 35023)	35023-1417	1
FENDER-REAR,FR (Ref # 35023A)	35023-1574	1
BOLT,6X20 (Ref # 92001)	92001-1765	4
SCREW,6X12 (Ref # 92009)	92009-1744	4
GROMMET (Ref # 92071)	92071-1228	1
COLLAR (Ref # 92143)	92143-1307	4
BOLT,6X14 (Ref # 92150)	92150-1133	4