

2000 Vulcan 800 Classic PARTS DIAGRAM

Frame

F2120

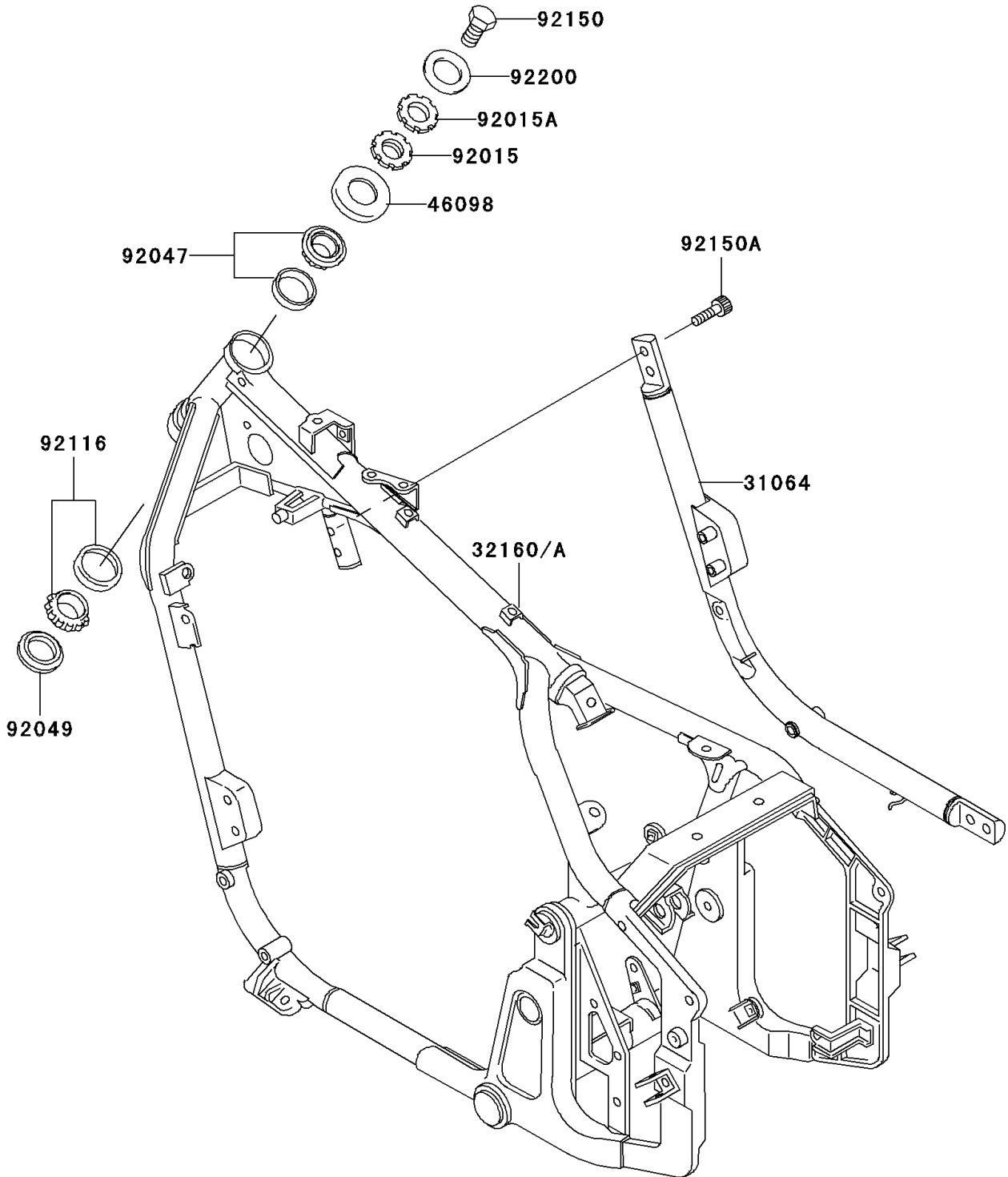

2000 Vulcan 800 Classic PARTS LIST

Frame

ITEM NAME	PART NUMBER	QUANTITY
PIPE-COMP,DOWNTUBE,RH (Ref # 31064)	31064-1176	1
CAP,STEERING STEM (Ref # 46098)	46098-017	1
NUT,25MM,T=10 (Ref # 92015)	92015-1377	1
NUT,25MM,T=6 (Ref # 92015A)	92015-1378	1
RACE,ROLLER,32005JR RS (Ref # 92047)	92047-017	1
SEAL-OIL,XMHE36X52X4J (Ref # 92049)	92049-1162	1
BEARING-ROLLER,HR320/28XJ (Ref # 92116)	92116-1009	1
BOLT,14X25 (Ref # 92150)	92150-1672	1
BOLT,SOCKET,10X23 (Ref # 92150A)	92150-1942	4
WASHER (Ref # 92200)	92200-1140	1
FRAME-COMP,FR (Ref # 32160)	32160-1400	1
FRAME-COMP,FR (Ref # 32160A)	32160-1502	1